

For New Technology Network

NTN[®]

L i g h t

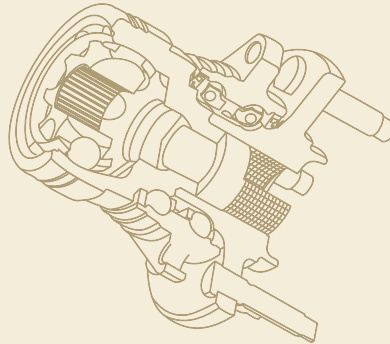

C o m p a c t ▶

◀ *M o d u l a r*

Choose NTN

M o d e r n



A n n u a l R e p o r t 2 0 0 2

Year Ended March 31, 2002

Corporate Profile

for New Technology Network

Contents

1	Corporate Profile
2	Financial Highlights
3	To Our Shareholders
7	Special Feature: NTN Structural Reforms
9	Review of Operations
	Bearings
	Constant-Velocity Joints
	Precision Equipment
19	NTN's Technological Assets
23	Environmental Activities
25	Financial Review
28	Five-Year Summary of Selected Financial Data
29	Financial Statements
42	NTN Group Investment Holdings
43	NTN's Global Network
45	Management
46	Investor Information

Since its establishment in 1918, NTN Corporation has been a pioneer in developing and manufacturing products that have shaped a variety of industries. Through the development of innovative constant-velocity joints, which are key components of automobile drivetrains, we have captured the largest share of the Japanese market. The ultra-high-precision technology that we have cultivated over the years through the production of bearings has enabled us to diversify our line of products to include a range of precision equipment, including liquid crystal display (LCD) repair devices and parts feeders.

NTN started to expand its business abroad early in 1961 by establishing key sales and production bases worldwide. To provide our customers with the products and technology to serve their needs best, we make the most of a global sales network based in four

strategic regions covering Japan, the Americas, Europe and Asia.

With unparalleled experience, breadth and resources, NTN will continue to open the door to new, innovative technologies and serve as a valued citizen of the international business community.

Notice

This annual report contains forecasts and projections regarding NTN's future plans, strategies and business results. Please note that actual business results may vary from the projections made herein by the Company.

Financial Highlights

NTN CORPORATION and consolidated subsidiaries
Year ended March 31

	Millions of yen except per share amounts			Thousands of U.S. dollars except per share amounts
	2002	2001	2000	2002
FOR THE YEAR				
Net sales	¥ 324,339	¥ 340,551	¥ 326,474	\$ 2,434,064
Operating income	8,140	14,335	9,675	61,088
Income (loss) before income taxes and minority interests	(701)	6,888	(41,822)	(5,260)
Net income (loss)	(132)	4,289	(24,677)	(991)
PER SHARE DATA				
Shareholders' equity	¥ 299.27	¥ 299.44	¥ 310.77	\$ 2.25
Net income (loss)				
-Basic	(0.29)	9.26	(53.30)	(0.00)
-Diluted	—	8.78	—	—
Cash dividends	5.50	6.00	6.50	0.04
AT YEAR-END				
Total assets	¥ 462,895	¥ 478,945	¥ 494,677	\$ 3,473,884
Shareholders' equity	138,532	138,625	143,874	1,039,640
Number of employees	11,989	12,619	12,770	11,989

Notes: U.S. dollar amounts have been translated from yen, for convenience only, using the approximate exchange rate at March 31, 2002, which was U.S.\$1 = ¥133.25.

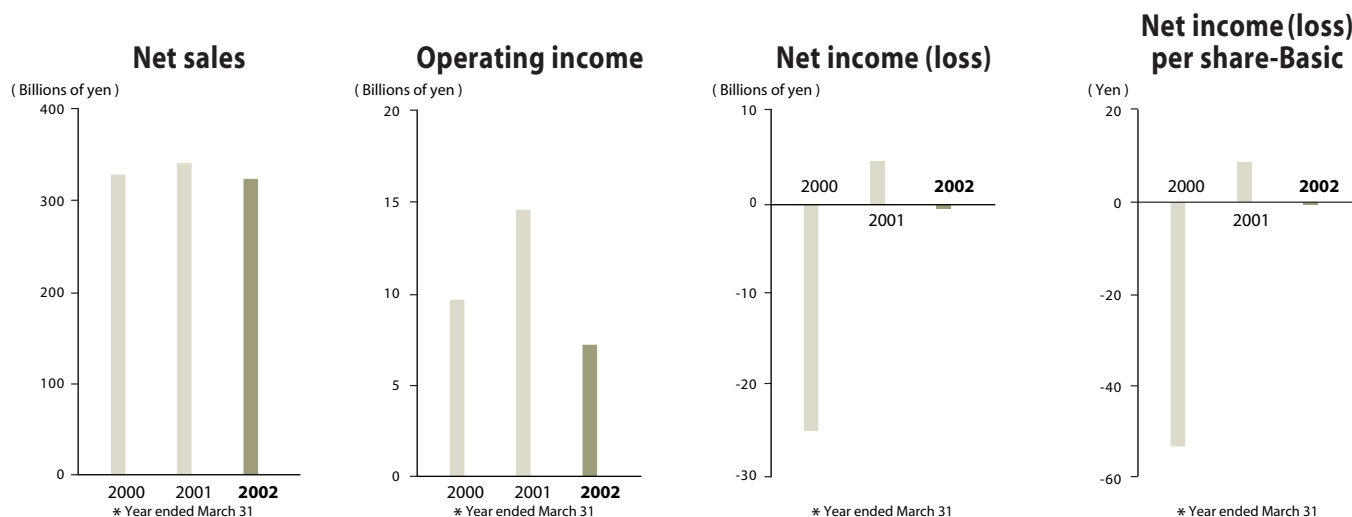

To Our Shareholders



Yasunobu Suzuki, President

Fiscal 2001, ending March 31, 2002, was a period of sudden change and difficult economic conditions. It also marked a turning point for NTN.

We mourned the untimely passing of Former President Toyoaki Itoh on November 6, 2001. Mr. Itoh was a driving force behind building an alliance with FAG Kugelfischer Georg Schäfer AG of Germany and establishing the joint venture with Renault S.A. of France for the production of constant-velocity joints (CVJs) as part of a global business strategy. On November 12, I took over as the new president of NTN, and have committed myself to furthering the Company's objectives amid difficult business conditions. To revitalize our corporate structure, which has been weakened by the drastic changes in the business environment and market structure, we implemented a new structural reform plan in April 2002. This plan will ensure continued growth and profit while creating a stronger company that puts shareholders and customers first.

Overview of Fiscal 2001

During the fiscal year ended March 31, 2002, the Japanese economy experienced a decline in stock prices, growing deflationary concerns, higher unemployment and a worsened income environment, which led to continued sluggish consumer spending. The collapse of the information technology (IT) industry bubble in the U.S. affected industries in Japan, production was adjusted in response to lower exports, and capital spending fell. This economic turmoil had an impact on every industry in Japan and sent the country further into an economic downturn.

In other regions around the world, the U.S. economy experienced a slowdown as a result of a slump in the IT industry and lower capital spending despite relatively healthy personal spending. While a sense of stagnation was felt in certain countries in Europe, overall, the regional economy showed steady growth driven by vigorous personal spending. Although it appeared that the economies of certain countries in Asia had bottomed out, the region's dependence on the U.S. economy created overall sluggish conditions.

Amid this difficult business environment, our consolidated performance during the fiscal year resulted in a decline in sales and income compared to the previous year.

Sales to North America and Europe increased during the year, but a large drop in sales in Japan resulted in consolidated net sales declining 4.8% from the previous term to ¥324.3 billion.

Operating income decreased 43.2% to ¥8.1 billion due to a drop in production and sales, lower sales prices (despite the weakening of the yen against both the dollar and the euro), as well as our efforts to reduce the cost of raw materials and enhance plant productivity.

Other income totaled ¥4.3 billion, including ¥3.2 billion in gains on the sale of a plant site and other fixed assets. Other expenses came to ¥13.1 billion, including ¥4.2 billion in interest expenses, ¥3.4 billion as a loss on write-down of investment securities and ¥1.8 billion in payments of U.S. antidumping duties for prior periods. As a result, net loss before income taxes and minority interests was ¥0.7 billion and net loss was ¥0.1 billion.

As business conditions are predicted to remain difficult over the next term and severance pay is expected to increase with personnel reductions, the year-end dividend per share

was ¥2.5, or ¥0.5 lower than the dividend for the previous term. Together with the interim dividend, which was already paid out, the annual dividend was ¥5.5 for the fiscal year.

Total assets at year-end were ¥462.9 billion, a ¥16.1 billion decrease from the previous term. In an effort to streamline our balance sheets, we concentrated on reducing inventories and interest-bearing debt. As a result, we succeeded in cutting inventories by ¥7.9 billion and interest-bearing debt by ¥1.2 billion as planned. When the effect of the exchange rate is excluded, the actual decreases were ¥9.8 billion and ¥5.2 billion, respectively. These reductions are contributing to solid improvement in the Company's financial standing.

Company Reform Efforts During the Fiscal Year

Although the fiscal year was a period of unfavorable results, NTN was successful in strengthening the corporate structure through reform efforts. In Japan, we liquidated NTN Precision Forging Co., Ltd. (Japan) in January of 2002 to help streamline and concentrate our business operations. In North America, personnel costs were reduced, thereby decreasing fixed costs at NTN-Bower Corp. and NTN-BCA Corp., companies responsible for the manufacture of ball bearings and tapered roller bearings, which have experienced low sales.

The Management System Transformation Project (e-NTN program) launched in April of last year aims to create the ultimate business model comprised of four management groups: the Customer Relationship Management (CRM) Group, whose goal is to enhance customer satisfaction and expand the market share of NTN products among its customers; the Supply Chain Management (SCM) Group, whose purpose is to shorten the total lead time and reduce inventory by 50% while reducing total costs by 30%; the Product Development Management (PDM) Group, whose aim is to shorten the product development and design time while strengthening the product development system; and the Business System Management (BSM) Group, which lays the groundwork needed to support the above three groups. After a year of planning activities, the plans created by each group were ready to be implemented by other divisions within the Company. At the end of March of 2002, NTN assigned the plans of the CRM, PDM and BSM groups to the respective

divisions. Meanwhile, the SCM Group will continue its project activities to further expand the Company's e-NTN program to all plants (except pilot plants), with a goal of making the program fully operational by the end of March of 2003.

NTN is also pursuing the formation of partnerships with bearing manufacturers to strengthen its business performance. With the takeover of FAG by INA of Germany in autumn of last year, talks of building an alliance with FAG have been temporarily halted, but NTN continues to pursue the possibility of working with the newly acquired bearing manufacturer on projects as part of the Company's commitment to enhancing customer satisfaction through global alliances. To secure and maintain the global competitiveness of bearings produced in Japan, we are pursuing a comprehensive alliance with Japanese bearing manufacturer NSK Ltd. covering sales, manufacture, engineering and procurement for large-size bearings.

To satisfy growing demand for axle units, one of our strategic products, we are concentrating on expanding production facilities, especially for our third-generation hub bearings. During autumn of last year, we received new orders for CVJs from DaimlerChrysler in North America and Europe and the GM group in Europe. In response to these new orders, a new plant is now being constructed at NTN Driveshaft, Inc. in the U.S. and new facilities are being added at NTN Transmissions Europe in France to meet the rising demand.

Meanwhile, R&D work from the NTN Technical Center (U.S.A.), Inc. was moved to the NTN Automotive Center of NTN Bearing Corp. of America to concentrate on and strengthen product development for the North American automotive market.

Structural Reform for the 21st Century

As the rate of change in the business environment – including joint development, joint business, and growth of global alliances – continues to accelerate, decision-making must become swifter and more efficient than ever before. Upon taking the reins as president of NTN, I took the opportunity to create a corporate vision that will shift the path of the company to achieve rapid management decisions through a structural reform plan that will help us meet the evolving business needs of the 21st century.

To accomplish the "NTN Evolution for Worldwide (NEW) Plan 21," we are now focusing on becoming a company with a

high profitability independent of scale. We are shifting our managerial resources toward more profitable business while implementing full cost-cutting measures.

In sales, we are concentrating our managerial resources on strategic products for future growth of the Company. In particular, we aim to obtain the largest share of the worldwide market for CVJs and axle units – primarily in Western markets. We expect sales of CVJs to increase by approximately ¥20 billion (22%) to ¥106 billion over the next three years and sales of axle units to grow by approximately ¥6 billion (24%) to ¥32.5 billion over the next two years.

The most important factor in increasing sales of our products is how carefully we listen to the needs of the market and then answer those needs by involving everyone in the company. Now, more than ever before, it is essential to provide high-level technical sales and marketing in step with customer and market needs. We must also strengthen our global strategic sales capabilities to match the characteristics of the sectors in which our customers operate. In April of this year, we implemented organizational reform to focus on customer and market trends, then swiftly and flexibly respond to changes in those trends. This reform included the integration and restructuring of our sales and engineering divisions, as well as the appointment of Global Account Managers to provide comprehensive sales activities on a global level for eight distinct groups of automobile manufacturers worldwide.

In an effort to restructure production, we are working to transfer production to optimal locations around the world. We implemented a principle of competition within NTN to shift production from non-competitive locations to cost-competitive locations. During this process, we are restructuring ball bearing and tapered roller bearing production bases on a global scale. This restructuring includes integrating and shifting production among those bases to achieve maximum efficiency. We are also restructuring production to include an expansion of operations into China.

To facilitate faster product development, we are working to centralize all product development information and establish a round-the-clock development system, which targets a two-thirds reduction in current production time. In addition, we are using our wealth of technical expertise to develop groundbreaking next-generation equipment and reduce capital expenses by one half. To achieve this, especially with regard to our strategic products, we are strengthening our R&D and

prototype manufacturing divisions by increasing the number of highly motivated staff who are joining full-time development projects through an in-house job application system.

To strengthen the cost-competitiveness and profitability of the Company, we set a goal to reduce outside procurement costs, personnel costs and logistics costs by 20% over the next two years. As part of our efforts to achieve a reduction in outside procurement costs, we are conducting price negotiations on a global scale corresponding to optimal worldwide production locations for our individual products. In an attempt to lower personnel costs, we are considering the implementation of measures, which include the introduction of an early retirement program as well as the review of our retirement benefits system and various allowances in Japan. To reduce logistics costs, we will continue full outsourcing effort as well as the implementation of reforms to create a structure that provides services which are competitive with market prices.

Strengthening Our Foothold in China

To strengthen our operations in China, in August 2002 we will establish Shanghai NTN Corporation, a joint venture with Okaya & Co., Ltd. (with NTN owning 95% of the subsidiary) for the production of CVJ components and bearings in Shanghai. The goal of establishing this joint venture subsidiary is to strengthen the presence of NTN in the steadily expanding Chinese automobile market by creating a production base in China and a supply base for the export of manufactured and semi-manufactured strategic products (axle units, needle roller bearings and CVJs) to NTN group production bases in Japan, North America, Europe and the rest of Asia, to enhance the global price competitiveness of these products. In keeping with these objectives, we plan to export approximately 90% of all components and products manufactured at this subsidiary.

The second measure to maximize our operations in China is to establish Guangzhou NTN-Yulon Drivetrain Co., Ltd. in the city of Guangzhou, China in October 2002 for the production of CVJs. This will be a joint venture company with Yulon Group (Taiwan), which manufactures automobiles through South East Motor Corporation and Aeolus Motor Corporation in China, with NTN owning 60% of the subsidiary. By making the most of NTN's technical expertise and Yulon Group's business experience in China, this joint venture

company will become a base for CVJ production in China and enhance our competitiveness in terms of quality, price, delivery time and customer service. Through the subsidiary's manufacture and sales of CVJs, we will be able to respond to the local procurement needs of growing Chinese automakers and strive to further expand our CVJ operations in China.

There is a growing shift among manufacturers toward adopting fluid dynamic bearing technology in hard-disk drive motors. In addition, more of our customers are moving their operations to China. To quickly respond to these trends, we will establish a joint venture in Pinghu, China by the end of August 2002 for the production of fluid dynamic bearing units. NTN-Nidec (Zhejiang) Corporation will be jointly owned by NTN (60%) and Nidec Corporation, a major manufacturer of hard-disk drive motors. We will also begin production of sintered-alloy fluid dynamic bearings, a core product of fluid dynamic bearing units, in December 2002 at NTN Manufacturing (Thailand) Co., Ltd., a wholly-owned subsidiary in Thailand.

It is imperative that these reforms be achieved with a strong sense of urgency and responsibility shared by everyone in the Company, including myself. As the new president of NTN, I will ensure that together as a company, we will devote all of our efforts to accomplishing these reforms. Two years after these structural reforms are complete, we expect to achieve cost reductions of ¥40 billion on a consolidated basis and an operating margin of approximately 8%. The key to this success lies in the capabilities and efforts of every single employee. Therefore, we will concentrate on the cultivation of personnel that will lead us into the 21st century.

We greatly appreciate your ongoing support and look forward to providing all of our shareholders with encouraging news of the direction and progress of our structural reform efforts under "NEW Plan 21" as we continue to forge ahead in the year to come.

June 27, 2002
Yasunobu Suzuki
President



The Start of the NTN Evolution for Worldwide Plan 21

NTN has launched its structural reform plan "NTN Evolution for Worldwide (NEW) Plan 21." This set of business reforms will be implemented over the course of two years to achieve profitability that is independent of scale through drastic cost-cutting measures and by concentrating managerial resources in high value-added fields. At the same time, we will be continuing to put our shareholders and customers first.



1 Strengthening Business Development Capabilities

Streamlining and concentration of business and expansion of strategic product sales

We are concentrating our managerial resources on strategic products necessary for the future growth of the Company. In particular, we are aiming to obtain the top market share in the world for constant-velocity joints (CVJs) and axle units by increasing sales of these products. Our strategic products include CVJs, axle units, needle roller bearings, precision bearings, aerospace bearings and automobile clutches.

Organizational reform

Reforms were implemented in April 2002 to create an organization that can flexibly respond to changes in market trends and customers' needs as they accelerate globalization of their operations. By integrating and restructuring sales and engineering divisions, a comprehensive system was established to meet customer and market needs. Meanwhile, an integration of R&D divisions will reduce product development time.

Keys to organizational reform

I. Integration of sales and engineering divisions

- Focus on customer and market trends, integrate and restructure sales and engineering divisions, and establish the Automotive Sales Headquarters and Industrial Sales Headquarters.
- Newly appoint Global Account Managers (GAM) to the Automotive Sales Headquarters.

II. Integration of R&D divisions

Integrate R&D divisions to establish the Research & Development Center in order to develop major proprietary products with a cross-organizational development system (full-time project system) for strategic product development.

III. Establishment of independent business unit for precision equipment

Establish the Precision Equipment Division to recognize precision equipment operations as an independent business unit.

2 Strengthening Profitability

We will take steps to strengthen NTN's earning power so that it can outpace fierce global competition. Outside procurement costs, personnel costs and logistics costs will be reduced 20% within a two-year period.

Keys to strengthening profitability

I. Reduction of outside procurement costs

- Review purchase price based on product strategy (including VAVE).
- Reorganize and consolidate suppliers.
- Expand global procurement.
- Expand local procurement.

II. Reduction of personnel costs

- Implement an early retirement program.(Japan)
- Review retirement benefits system.(Japan)
- Review various allowances.(Japan)

III. Reduction of logistics costs

- Review logistics costs.
- Reduce costs by integrating and eliminating distribution bases.
- Reduce costs by outsourcing.

3 Restructuring Production

To strengthen corporate competitiveness, we are making efforts to shift production from areas where there is demand to optimal production locations. Through integrated production, we are improving production efficiency and strengthening our foundation for profitability.

Keys to production restructuring

I. Restructuring in Japan

Integrate production, mainly of ball bearings and tapered roller bearings, while shifting the types of products produced and equipment among five major plants within Japan.

II. Restructuring in North America and Europe

- Rationalize production at NTN-BCA Corp. (U.S.A.)
- Restructure operations by shifting production of radial ball bearings from NTN Kugellagerfabrik (Deutschland) G.m.b.H. (Germany) to Eastern Europe through an alliance.

III. Expansion into China

- Establish joint venture company for manufacture of needle roller bearings, axle units and CVJ components.
- Establish joint venture company for manufacture of finished CVJs.
- Establish joint venture company for manufacture of fluid dynamic bearing units.
- Outsource production of some radial ball bearings to affiliated company (Shanghai Tungpei Enterprise Co., Ltd.)

4 Enhancing Product and Equipment Development Capabilities

We are strengthening our strategic product development system to ensure future business expansion and development. At the same time, we are building a framework to provide significantly shorter development time for more flexible product development that can meet the ever-changing needs of the market. We are also working to develop next-generation equipment to give our business the technological and manufacturing lead in the first quarter of the 21st century.

Keys to enhancing product and equipment development capabilities

I. Strengthening product development capabilities

- Reduce development time by two-thirds.
- Establish a round-the-clock development system.
- Strengthen prototype manufacturing by enhancing testing facilities and human resources.

II. Strengthening equipment development capabilities

- Reduce equipment costs by 50% compared to fiscal 2001.
- Develop next-generation equipment that is low-cost, compact and high performance.

Projected Cost Reduction (Consolidated)

Our goal is to achieve cost reductions of approximately ¥40 billion on a consolidated basis, and we estimate an operating margin of approximately 8% upon completion of these structural reforms at the end of March 2005.

Target cost reductions after completion of structural reforms

	(Billions of yen)
Outside procurement costs	20
Personnel costs	15
Logistics costs	2
Production restructuring	3
Total	40

Review of Operations



Bearings

Major products

- Ball bearings
- Roller bearings
 - Needle roller bearings
 - Tapered roller bearings
 - Cylindrical roller bearings
 - Spherical roller bearings
- Axle units
- Bearing units
- Oil-impregnated sintered bearings
- Engineering plastics sliding bearings, etc.

Bearing sales ratio
(% of total sales)

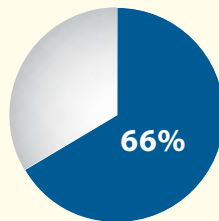

Global bearing market
(Billions of yen)

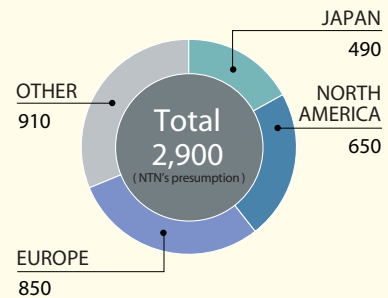

Bearings are NTN's main business, accounting for 66% of consolidated sales. Currently, NTN bearings have a 26% share of Japan's market and 8% of the global market.

NTN began international expansion of its sales offices in the 1960s and followed with the development of a global manufacturing network a decade later. Today, NTN is using its expertise as a leading bearing manufacturer to create new value-added products and services to meet the needs of its customers in the automotive, machinery, semiconductor, IT, medical, biotechnology and other industries.

Overview of Performance

Although sales of bearings to auto manufacturers in Europe increased during the fiscal term, sales in Japan fell due to production cutbacks in the general machinery industry and inventory adjustments by distributors and customers. Demand also dropped off in North America. As a result, consolidated sales were ¥215.6 billion, down 6.3% or ¥14.5 billion from last year.

During the first half of the fiscal year in Japan, NTN posted strong sales of bearings for the automotive sector but a drop in overall demand for automobiles in the second half, coupled with sluggish sales to general machinery manufacturers and distributors, led to overall sales of ¥104.7 billion, a decrease of ¥16.4 billion, or 13.5%, from the previous fiscal year. With a downturn in individual consumption, lower corporate investment and an accelerating trend among domestic automakers to shift from exporting parts to local procurement of parts overseas, a full-fledged recovery in demand is not anticipated. The restructuring of five domestic production plants, focusing mainly on the manufacture of ball bearings and tapered roller bearings, is in progress. Production efficiency is also being enhanced through consolidated production.

In North America, despite the impact of the weakened yen, demand fell for bearings in the automotive and general machinery sectors. Overall sales for the fiscal term were ¥60.7 billion, down ¥0.7 billion or 1.1%, from the previous year. Ball bearings, tapered roller bearings, axle units, needle roller bearings, and

other NTN products are currently being manufactured at seven locations in North America, and plans are in place to provide capital investment to strengthen capacity for strategic products, which include axle units and needle roller bearings. More specifically, capacity is being reinforced for the development of third-generation hub bearings – a type of axle unit. Production of needle roller bearings for use in transmissions began in October of 2001 as NTN's first step toward global expansion of needle roller bearing sales.

Due to an increase in sales to the automotive industry and the effect of the weakening of the yen, sales in Europe climbed ¥2.7 billion, or 12.1%, from the previous fiscal period to ¥25.4 billion. During the year, new orders were received for our axle units and other strategic products. The alliance with FAG is enabling NTN to reorganize its production operations by shifting the manufacturing base for ball bearings from Germany to Eastern Europe.

Despite the weakening of the yen and an increase in locally manufactured bearings in Thailand, the effect of stagnant economic conditions among ASEAN countries led to lower sales in Asia and other areas, which declined ¥0.06 billion, or 0.2%, to ¥24.8 billion.

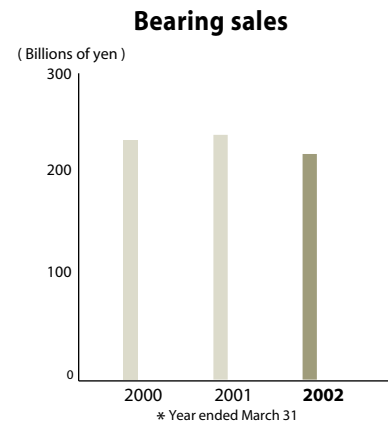

Bearings
Bearings
Bearings
Bearings

Bearings

The NTN Advantage

NTN offers a diverse range of bearing products. Its strategic products include axle units, needle roller bearings, precision bearings and aerospace bearings, which represent the culmination of our unique technological expertise. NTN foresees continued growth in these products, and by combining its business development, manufacturing and R&D abilities, it aims to become the world leader in bearings.

Third-generation Hub Bearings

NTN is at the forefront when it comes to third-generation hub bearings, which require advanced technological design and enable greater unitization.

A continuing shift from earlier generation hub bearings to third-generation hub bearings is expected to provide greater business opportunities for NTN. NTN has already pioneered the world's first third-generation hub bearings with wireless ABS sensor. With these value-added products, NTN will continue to strengthen its market share in third-generation hub bearings.



Wireless ABS Sensor System

The self-generated power from a microgenerator inside the bearing enables the wireless transmission of the torque signal from the wheel (bearing) to the receiver inside the wheel housing, essential for the operation of anti-lock braking systems (ABS), which are becoming a standard feature in passenger cars and popular among automobile manufacturers. Automakers have a strong interest in NTN hub bearings and hubjoints with wireless ABS sensor because these devices do not require wiring during assembly, thereby eliminating problems due to wire damage caused by impact from road debris.



Fourth-generation hubjoint with wireless ABS sensor

Fourth-generation Hubjoints

A fourth-generation hubjoint is a high-performance modular product that combines a third-generation hub bearing and a constant-velocity joint (CVJ). By making the most of the technologies of both bearings and CVJs, NTN is continually pursuing the development of a fourth-generation hubjoint with the smallest and lightest design possible. This concept will put a new high-tech product to practical use. The design allows for more than 10% less weight for greater fuel efficiency and operational stability. The axial lengths have been reduced by 20% for greater flexibility in chassis design. As a result, NTN's fourth-generation hubjoints are now gaining the attention of numerous automobile manufacturers.



Fourth-generation hubjoint

Needle Roller Bearings

Sales of NTN needle roller bearings lead the market, commanding a 40% share of Japan's market. NTN needle roller bearings feature high load capacity in a compact design for effective use of space. Demand for this type of bearing has continued to grow in recent years. Extending bearing life has become an increasingly important issue as the operating conditions of needle roller bearings have become more extreme. NTN's advantage is in its ability to respond with proprietary technologies.

HL surface processing technology developed by NTN is a perfect example where best-in-class technology is exploited. This NTN patented technology minimizes the problems that can reduce bearing life, such as peeling, when lubrication conditions are poor. NTN also makes use of a technology that applies a special heat treatment to the bearing material to ensure a lifetime two or three times longer than that of standard bearings. NTN's needle roller bearings feature an outstanding value when combining NTN's advanced manufacturing technologies.

Although NTN's needle roller bearing operations had long been centered in Japan, it expanded its manufacturing operations overseas to Thailand in 1999 and the U.S. in 2000. NTN will continue to increase worldwide sales of bearings that utilize the Company's advanced technology.

Needle roller bearings

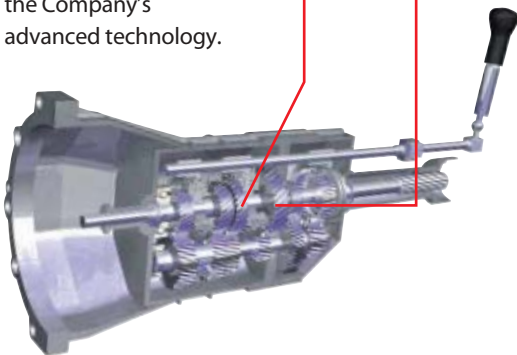

Precision Bearings with High-Tech Applications

NTN has earned a reputation for high-precision, high-quality bearings. For example, NTN aerospace bearings are used in the main shafts of jet engines manufactured by GE Aircraft Engines, the world's largest jet engine manufacturer. Moreover, NTN provided all 24 of the precisely manufactured bearings incorporated in the turbo pump and fuel valve of Japan's second H-IIA rocket, which was launched successfully in February 2002. Our high-tech bearings are also being used in the development of environmentally sound gas turbines as part of another nationally funded project. Whether it is to help create technologically advanced aerospace vehicles or help protect the environment, NTN's precision bearings are finding numerous high-tech applications.



Liquid hydrogen turbo pump bearings



©NASDA

Review of Operations



CVJ sales ratio
(% of total sales)

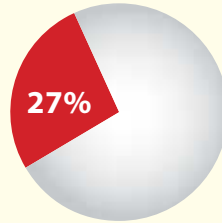

Global CVJ market
(Billions of yen)

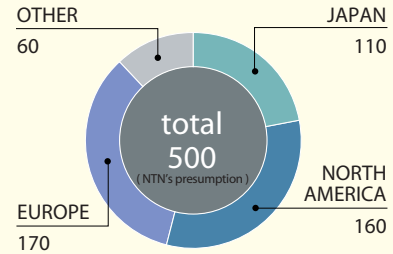

Constant-Velocity Joints

Major products

Automotive CVJs
(for halfshafts, propeller shafts
and steering shafts)
CVJs for industrial machinery

Constant-velocity joints (CVJs) are one of NTN's strategic products with strong growth potential. Currently CVJs account for 27% of consolidated sales. NTN CVJs represent 41% of Japan's market and 17% of the global market. NTN began producing CVJs at its Japanese plants in 1963. Beginning in the 1990s, NTN expanded production throughout the world. In response to the global sourcing needs of today's automotive industry, which represents a large consumer sector for CVJs, NTN has firmly established a strong base of operations supported by a trilateral development system covering the three key regions of Japan, the Americas and Europe. A quadrilateral production and sales system encompassing these three regions as well as other parts of Asia has also been formed. Making the most of its efficient operating systems and advanced technological expertise, NTN has established a solid reputation as a leader in the CVJ sector.

Overview of Performance

The increased manufacture of CVJs in Europe helped to bolster overall sales despite sluggish sales among Japanese customers, internal production of CVJs by auto manufacturers and intensifying price competition in Japan. Consolidated sales rose ¥0.47 billion, or 0.5%, from the previous year to ¥86.8 billion.

With major customers in Japan reducing production and shifting procurement overseas, overall CVJ sales in Japan fell ¥7.3 billion, or 13.8%, compared to the previous fiscal year, to ¥45.8 billion. Amid a decrease in total automobiles manufactured in Japan coupled with the growing trend among automobile manufacturers to shift from exporting domestic parts to procuring local parts overseas, NTN is working to strengthen its R&D division and earning power to achieve high profitability independent of scale.

Despite production cutbacks at the Big Three automakers, favorable sales of CVJs to Japanese transplant companies and a weakening of the yen contributed to strong sales in North America. Overall sales in this region reached ¥27 billion, up ¥2.5 billion, or 10.4%. NTN Driveshaft, Inc. (U.S.) is a producer of CVJs and is increasing production capacity, to supply business from Japanese transplant companies and new orders. While 340,000 CVJs are produced a month now, plans are underway to increase monthly production to around 420,000 units to meet new orders from DaimlerChrysler in fiscal 2004.

The expansion of CVJ production at NTN Transmissions Europe (France), or NTE which began operations during the second half of 2001, contributed to ¥10.7 billion in overall sales in Europe, a jump of ¥5.4 billion, or 102.7%, from the previous year. While French automaker Renault accounts for a majority of the CVJ manufacturer's sales, NTE has strengthened its market presence and stimulated new orders from other companies. NTE has expanded monthly production capacity to 220,000 units and expects to increase this to around 400,000 by fiscal 2004.

NTN's sales in Asia and other areas were adversely affected by the stagnant economies of ASEAN nations and the sluggishness of the Korean automotive industry. Overall sales dropped ¥0.18 billion or 5.0%, from the previous fiscal year to ¥3.3 billion.

To facilitate interaction with automotive manufacturers on a global level and to implement business strategies for each automotive and CVJ customer, NTN appointed Global Account Managers (GAM). They are the first of their kind in the bearing industry. By making the most of these vital positions, NTN aims to expand sales of CVJs and other products.

CVJ sales

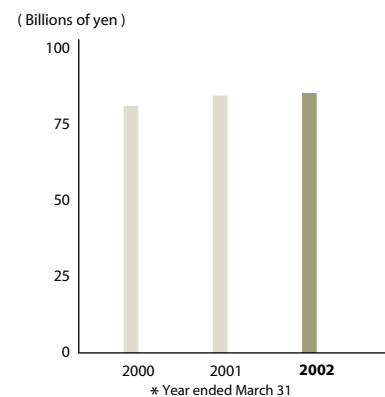

Constant-Velocity Joints
Constant-Velocity Joints
Constant-Velocity Joints

Constant-Velocity Joints

The NTN Advantage

With the increase in more fuel-efficient front-wheel drive vehicles largely stemming from the energy crisis of the early 1970s, CVJs became a key component of front-wheel drive systems. Over the years, passenger comfort and environmental considerations have also become important needs in the automobile market. Today we are witnessing radical innovations in technology to achieve these needs. As the requirements of CVJs become ever more advanced in terms of development costs and time, automobile manufacturers are relying more on outsourced CVJ production. This change of direction is creating greater business opportunities for NTN. NTN will make the most of these opportunities to strengthen the global market share of its best-in-class CVJ products.

Developing New CVJs that Anticipate the Needs of the Automotive Industry

Today it is essential that automobiles be made more fuel-efficient to reduce carbon dioxide and other harmful emissions. CVJs used in drivetrain systems must be made lighter and operate with less vibration in addition to transmitting the engine torque at a constant velocity. In response to these demands, NTN has developed the EBJ and EUJ fixed joints and EDJ plunging joints. These designs are more compact and efficient than conventional CVJs, Additionally, a PTJ plunging joint,

having minimal vibration, has also been developed. These new products not only greatly improve fuel efficiency, but they also enhance passenger comfort and ensure the manufacture of higher quality and performance automobiles. As a leading CVJ manufacturer, NTN will continue to create CVJ products that are even lighter and have less vibration to help meet the needs for tomorrow's automobiles.

New CVJ Applications: Propeller Shaft CVJs

The majority of CVJ production is primarily targeted for automobile halfshafts. Subsequently, CVJ production has increased in conjunction with the growing number of front wheel drive vehicles. However, in recent years, CVJs are being increasingly used in propeller shafts, taking the place of traditional cross joints. Unlike cross joints, CVJs are able to minimize noise, vibration and harshness and provide greater design flexibility.

NTN now offers a variety of best-in-class CVJs for use in propeller shafts, including the HLJ, EBJ and EDJ. With the growing demand for quieter vehicle operation and less vibration, the trend toward CVJ-equipped propeller shafts is expected to gain momentum. NTN expects sales to soar by making the most of a diverse product line and technological leadership in the area of high-speed propeller shafts.



Becoming a Leader in CVJ Technology

A constant-velocity joint (CVJ) is a type of joint used in the drive section of an automobile or machinery to constantly transmit torque when the input shaft and output shaft are rotated at an angle. CVJs are an essential component of automobile front-wheel drive systems, which are today the mainstream drivetrain systems in the market. CVJs allow the front wheels to absorb road shock separately and transmit the engine torque efficiently to the wheels to provide stable vehicle performance and enhanced passenger comfort.

NTN began providing CVJs in the 1960s at a time when front-wheel drive was still in its infancy. Since then, our operations have grown in tandem with the expansion of the front-wheel drive vehicle market. NTN became the first manufacturer to provide CVJs for full-time four-wheel drive systems in Japan. Today, NTN is determined to become a leader in CVJ technology, and has committed to the research and development of new products to anticipate the needs for CVJs that are lighter and have less vibration.

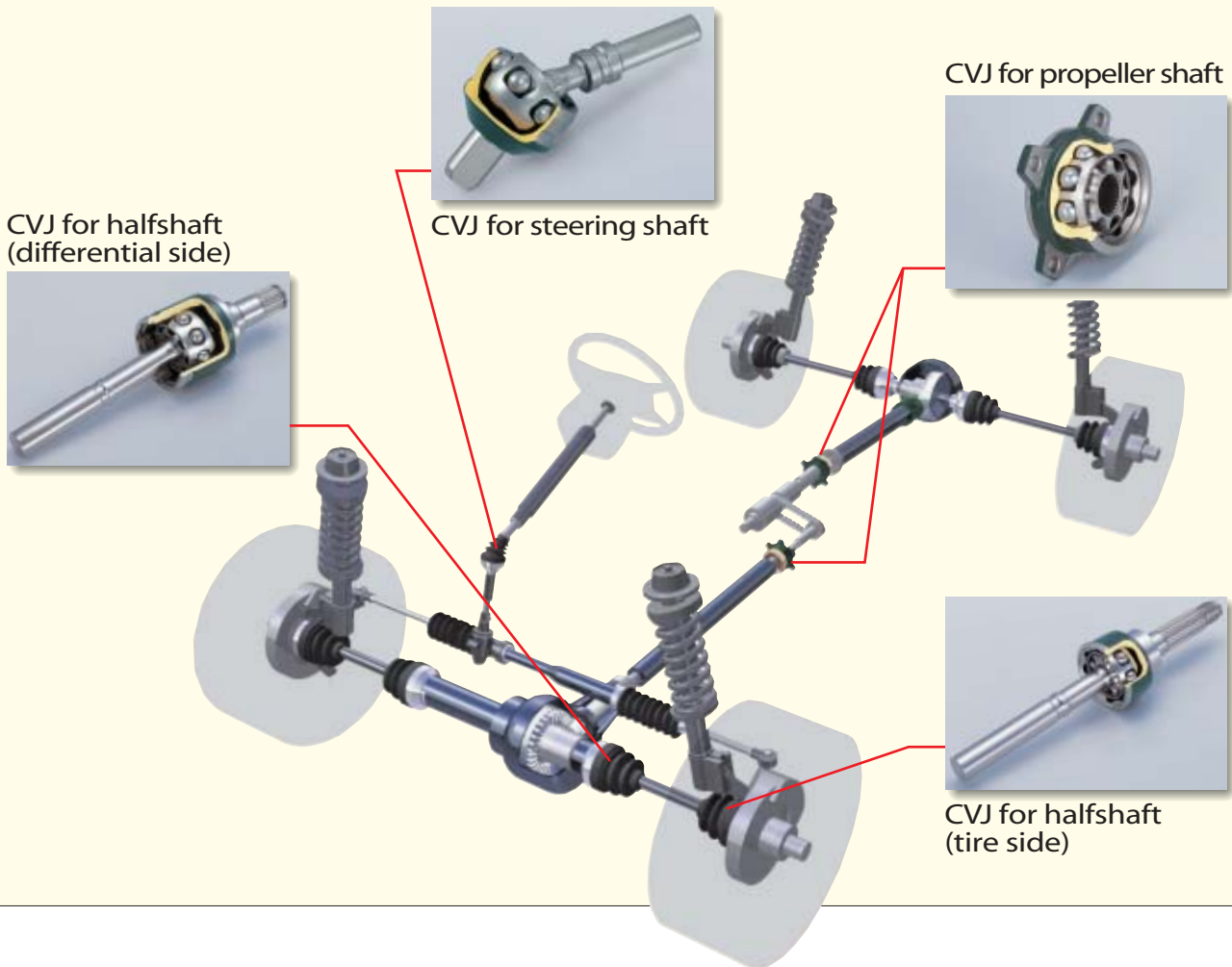

Review of Operations

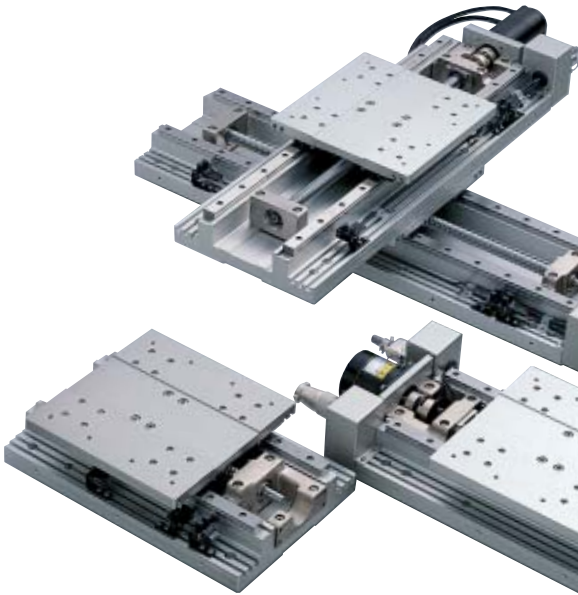

**Precision equipment
sales ratio**
(% of total sales)

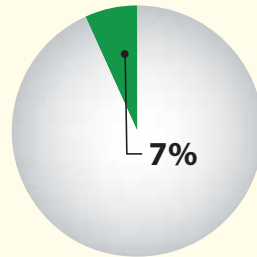

Precision Equipment

Major products

Auto-tensioners
Parts feeders
Ball screws
LCD repair devices
Magnetic-bearing spindles
Hydrostatic bearings
XY tables
Engineering plastics parts
Machine equipment, etc.

This business segment covers a wide range of products, including high-tech equipment and other application-specific products. It accounts for 7% of consolidated sales.

NTN continues to strengthen its technological expertise in mechatronics and to supply the IT and other industries with innovative precision products. Products such as LCD repair devices that efficiently repair and process defects in liquid crystal displays are targeted applications. NTN also offers parts feeders, which automatically align various types of parts for processing into production machinery at high speeds. The super-compact, high-speed SMD (surface-mounted device) feeder, designed and produced by NTN, enables high-speed alignment and feeding of microchips used in the mobile phone industry.

We also provide a diverse range of products for the automotive industry, including auto-tensioners, which automatically adjust the tension of the engine timing belt. Additionally various clutch products are being marketed, such as a mechanical clutch unit, which enables a vehicle to be shifted quickly and easily between different drivetrain systems.

Overview of Performance

The introduction of NTN's new mechanical clutch unit contributed to steady sales of precision equipment for the automotive industry; however, a downturn in IT-related industries and lower capital investment resulted in a drop in sales of LCD repair devices and parts feeders. Consolidated sales for precision equipment fell ¥2.2 billion, or 9.2%, from last year to ¥22 billion.

To flexibly respond to rapid technological innovations and production fluctuations in the semiconductor, liquid crystal, electronics and other industries

using precision equipment, NTN is making efforts to speed up product development by combining its development, sales and manufacturing capabilities into a single profit center. NTN is also focusing on expanding sales to Taiwan, Korea, Southeast Asia and other potential growth markets. It is putting strong efforts into developing new business in Japan and around the world. In particular, NTN is aiming to enhance its after-sales service division and cultivate it as a source of greater revenue.

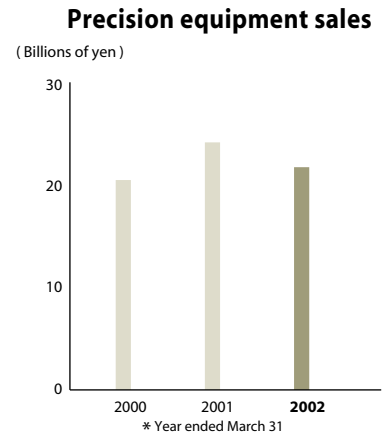

The NTN Advantage

NTN's clutch products are used in a wide range of applications, from business machines to automobiles.

NTN continues to develop innovative products that combine clutch and control technologies with particular focus toward expansion of the automotive product line.

All of NTN's clutch products mechanically provide the function of electromagnetic control while helping to conserve energy. As such, it is anticipated that they will become widespread in the future.

Mechanical Clutch Units

The FourTrax Foreman all-terrain vehicle, which went on sale in North America in the summer of 2001, is equipped with a special system that enables the rider to quickly and easily shift from two-wheel drive to four-wheel drive "on the fly." This is all accomplished with the simple push of a switch when off-road conditions call for extra handling. And the technology that makes it all possible is NTN's mechanical

clutch unit (MCU). This MCU also minimizes resistance and conserves energy while idling. Similar applications of this technology are expected in the future, including a two-wheel drive / four-wheel drive shifting mechanism in ordinary passenger vehicles. Another future application is a mechanism that can switch between the internal combustion engine and electric motor in hybrid vehicles.

Precision
Equipment
Precision
Equipment

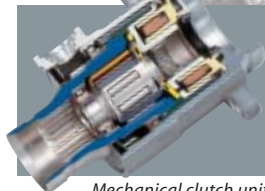

Mechanical clutch unit



NTN's Technological Assets

1. Enhancing Product Development with the Latest Analysis Technology

The use of computer-assisted analysis and performance prediction during the development and design of mechanical products can help designers and manufacturers greatly reduce the amount of prototype testing. In turn this decreases development lead-time and costs. NTN's major customers in the automotive, industrial and IT industries are turning to analysis-driven product design to satisfy their needs. They are showing a strong interest in the latest innovations of analysis technology which NTN provides as a product development business partner.

NTN continues to conduct research in analysis technology at its Research & Development Center in hopes of achieving the ideal product development process. When this analysis is used to the fullest capability, prototype testing is only needed during the final stages. This advanced analysis technology will not only reduce development lead-time and costs, but it will also help improve product performance. It will also provide easier and more accurate results which may not be understood solely through testing. The following is an introduction to our analysis technology and its applications.

► Analysis Technology: Creating Advanced, High-Quality Fluid Dynamic Bearing Units

Spindle motors employed in computer hard disc drives commonly use conventional ball bearings, but recently the trend has shifted toward the use of more advanced fluid dynamic bearings. In a fluid dynamic bearing, a set of grooves is created along the inner bore and end face of the bearing. Lubricating oil or a similar type of fluid is enclosed between the shaft and the bearing to enable the shaft to rotate without contacting the bearing. As a result, this type of bearing can achieve much steadier and quieter operation than that of a ball bearing. NTN fluid dynamic bearing units are based on an oil-impregnated sintered bearing, which contains lubricating oil within the actual bearing. This prevents sudden seizure and problems that can arise while reading data stored in a hard disc. NTN's product has a competitive advantage over others in this area. Moreover, the grooves of the bearing unit are created using a proprietary press for superior manufacturability, which allows for a cost competitive product.

At NTN, we are strengthening our R&D activities to enhance the performance and quality of our fluid dynamic bearing units. Analysis of the pressure distribution of fluid dynamic bearing units is just one of the many results of our efforts. The performance of a fluid dynamic bearing is primarily determined by the pressure distribution profile created on the oil film in the bearing clearance. We at NTN developed a program in December 2001 that analyzes this profile in the bearing clearance as well as within the sintered body. As a result, we are now able to view the pressure changes that were unexplained in earlier experiments and create an effective means of enhancing product performance by understanding certain phenomena that occur during operation of the product. As the demand for fluid dynamic bearings increases, NTN will continue to make the most of its outstanding analysis technology to stay at the forefront of this field.

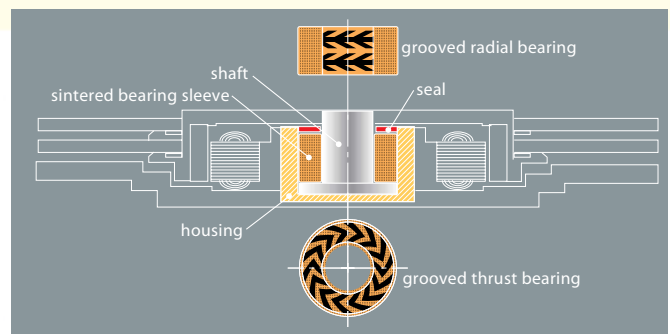
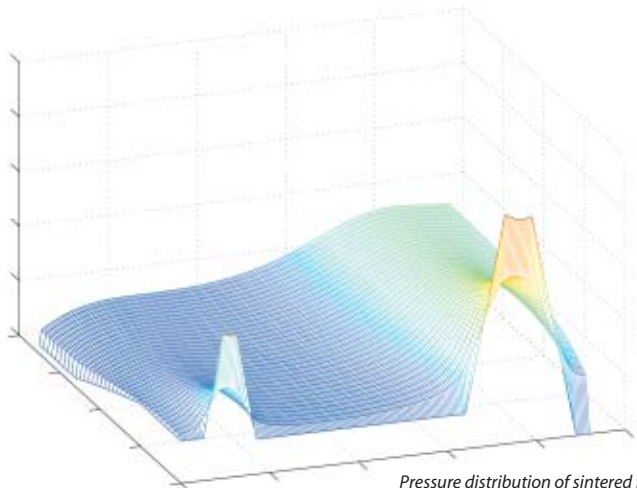



► Developing Analytical Methods for CVJs with 3D CAE

Constant-velocity joints (CVJs), a category of strategic products for NTN, are used in drive shafts of automobile to efficiently transfer power from the engine to the tires. Automobile manufacturers are continually in search of CVJs that are lighter, more compact and have a longer lifetime to improve performance. To meet this demand, it is essential to analyze the force and movements of the operating parts. Until now, it had been impossible to conduct quick and accurate analysis using visual means only.

In anticipation of these needs NTN established a new method of analysis by utilizing ADAMS® software. This software performs three-dimensional analysis based on computer assisted engineering. It provides visual analysis with three-dimensional computer graphics animation enabling the user to easily understand the internal movements of CVJs that cannot be verified with physical testing. By creating a three-dimensional visual representation of the analysis results, this software can aid in the development of higher quality products with an extended lifetime. Moreover, NTN will continue to use this method of analysis to develop products. This new tool is expected to greatly reduce the amount of prototype testing and, thereby, shorten development lead-time while reducing costs.

Major automotive manufacturers are now turning to NTN for various CVJ analysis models, allowing NTN to better serve their needs by actively participating in the early stages of the development of new automobiles models. Backed by its leading analysis technology, NTN is continuing its efforts to further expand market share of its strategic products.

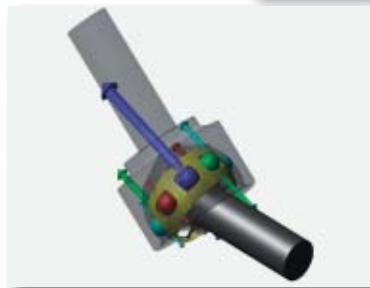
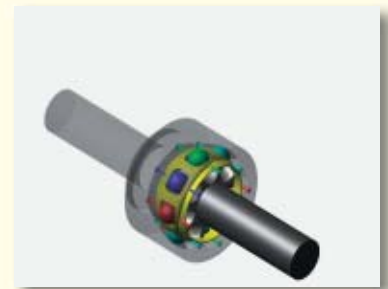

CVJ analysis using ADAMS®

2. Extending Product Life with Industry-Leading Materials Evaluation Technology

Demand is growing in the automobile and machinery industries for high-speed rotating bearings that are lighter, more compact and more durable. At NTN, we are committed to extending the life of our bearings, which is important to ensure greater durability, and the factor that determines bearing life is ultimately its material. Although bearing steel has to meet certain industrial standards, because the operating conditions of bearings become more rigorous each year, simply conforming to these standards does not ensure that a bearing will have the required quality. To solve this problem, NTN developed a materials evaluation system that utilizes image-processing technology.

One factor that adversely affects bearing life is non-metallic inclusions, impurities within the steel. Although it had been known that larger sized inclusions could adversely affect the lifetime of a bearing, NTN discovered that large amounts of small inclusions could also adversely affect bearing life. By quantifying the non-metallic inclusions, we succeeded in accurately estimating bearing life. Our materials evaluation system can be used to create images for the quick statistical quantification of non-metallic inclusions found on numerous cross-sections of steel. It features an extremely low margin of error compared to life test.

Our products are a true testament to this system. Because NTN bearings are manufactured using only those materials that have passed this evaluation system, their quality is constantly high. As NTN plans to strengthen its cost competitiveness by procuring more materials from overseas, it will be able to utilize this outstanding materials evaluation system to secure a stable supply of materials with an even higher level of quality.

NTN is proud to say that its materials evaluation system can provide the highest lifetime correlation of any other evaluation method worldwide. Utilizing this technology, we will continue to provide the highest quality to our customers.

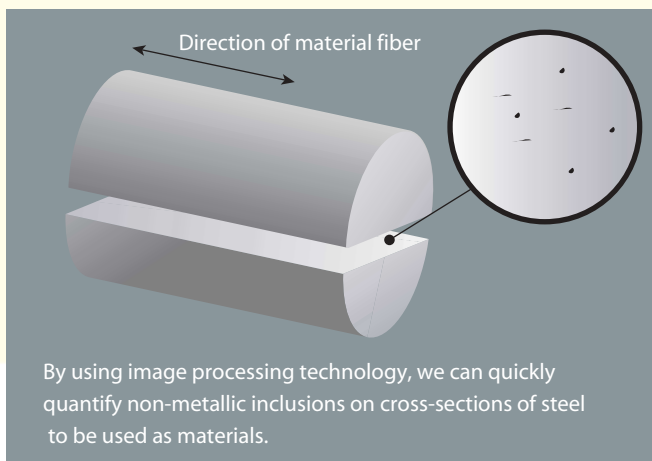

NTN's Technological Assets

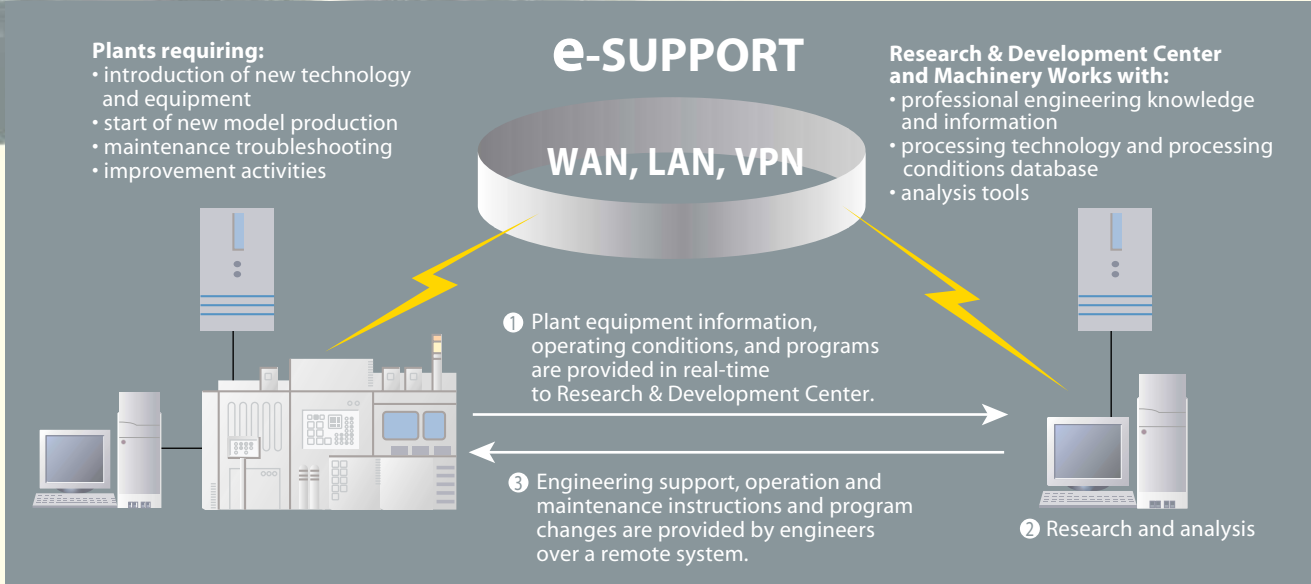

3. Enhancing Worldwide Production Efficiency with a Web-Based Production Engineering Support System

N NTN has developed and implemented an Intranet production engineering support system in its manufacturing plants in Japan and overseas. This will enhance the efficiency of product development and provide engineering support during both the installation of new production equipment and for machining, assembly and inspection processes that utilize new technology. The key technical advantages of this system are as follows; 1) it enables face-to-face communications between staff at different plants with the support of audio, video and image technology, 2) it provides a database of information from various equipment in real-time by connecting the control

terminals of the equipment over an Intranet, and 3) it provides web-based remote monitoring and maintenance by effectively using information collected from remote locations over the Intranet.

NTN makes the most of these system features to provide accurate technical support and instructions on how to improve operating programs. Using audio, video and images to check on the status of remote equipment and information collected from this equipment, we can accurately assess current manufacturing conditions.

Efficient support for production technology is essential when installing new equipment in overseas plants. Previously, teams were repeatedly

dispatched from Japan to overseas locations for engineering support and training. With this system, however, engineering training can be provided instantly and remotely from Japan as needed and a more efficient installation of equipment can be achieved. By helping to monitor the operational status of each piece of plant equipment and making the most effective use of the equipment, this system can also significantly enhance production efficiency. Wider applications of this system are currently being developed to help upgrade the production technology at optimal production locations worldwide.

Environmental Activities



Ensuring a society of sustainable development with minimal impact on the environment requires more effective environmental solutions. At NTN, we are constantly working to help protect the global environment by making environmental activities a top management issue of the Company.

▶ 1. ISO 14001 Certification

As part of its environmental activities, NTN obtained multisite certification for ISO 14001, the international standard for environmental management systems, in November 1999. By March 2001, most of our overseas plants had also received this certification. The newly established plants,

NTN Transmissions Europe and NTN Manufacturing (Thailand) Co., Ltd., are scheduled to obtain ISO 14001 certification by June 2003. Efforts are also being made to provide internal certification to affiliated companies that are not registered under the multisite certification.

Environmental management system certification of registration



▶ 2. Reduction of Global Warming

To control the amount of carbon emissions released into the atmosphere, which, along with other greenhouse gases, can contribute to global warming, NTN has formed a plan targeting a company-wide 20% reduction from fiscal 1997 levels of carbon emissions by fiscal 2010. Our efforts to reduce carbon

emissions during fiscal 2001 have resulted in a 5.3% reduction from fiscal 1997 level emissions. As a means of achieving this goal, environment-friendly cogeneration facilities are being constructed at Iwata Works with a target completion date of the end of November 2002.

Carbon emission rate

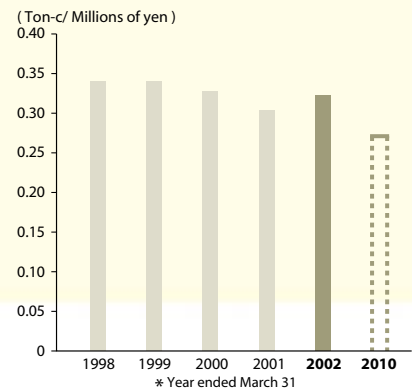

▶ 3. Reduction of Waste Materials

Grinding swarf (cutting waste made up of fine metal particles and grinding coolant) accounts for approximately 40 percent of the industrial waste generated by NTN operations. To reduce the amount of waste materials, NTN has developed a patented "compact grinding swarf briquetter" that compresses grinding swarf into solid briquettes while efficiently removing grinding coolant. The entire oil-based coolant extracted during the compression of the grinding swarf is recycled within the plant, and the briquettes are used as raw material by steel manufacturers. This device enables the recycling of all grinding swarf, and is expected to be installed in

eleven plants. This will help NTN achieve its "Zero emission" goal by helping eliminate all industrial waste by the end of March 2005.

A new recycling services company (Unitop Corporation) was established in May of 2002 to manufacture and market the "compact grinding swarf briquetter" and introduce the purchasers of the device to prospective users of the briquettes, such as steel manufacturers, and scrap traders that transport and recycle the briquettes. By providing key recycling services, NTN is helping to create a more environmentally conscious society.



Super-compact grinding swarf briquetter

▶ 4. Introduction and Effects of Environmental Accounting

NTN was the first Japanese bearing company to introduce environmental accounting, which analyzes the management of environment-related costs and the cost-effectiveness

of environmental activities annually. The first results of our environmental accounting were announced in the Environmental Report issued in June 2000. The introduction of our

“grinding swarf briquetter” will have a significant effect on operating costs, and we expect our cost-effectiveness be further increased.

Environmental Investment and Preservation Costs for FY 2001

(Millions of yen)

Category		Major activities/expenses	Environment-related capital investment	Environmental preservation expenses
Expenses incurred within manufacturing facilities	Pollution prevention	* Refurbishing specific facilities and waste water treatment facilities	156	90
	Global environmental preservation	* Adding inverter technology to motors * Reducing Halon fire extinguishers * Refurbishing air-conditioners	84	124
	Resource recycling	* Installation of grinding swarf briquetters and oil/water separation devices * Industrial waste disposal	82	554
	Subtotal		322	768
Expenses incurred before or after manufacturing process	Reducing environmental impact	* Improving packaging materials	0	0.3
	EMS building and operation	* EMS audit expenses * Environment-related personnel expenses	0	191
	Information disclosure and environmental advertising	* Newspaper and magazine PR/advertising expenses	0	22
	Monitoring and measuring	* Measurement of environmental impact on air and water expenses	0	28
Management expenses	Environmental education	* Environmental education expenses	0	5
	“Greening” of plant sites and surroundings	* “Greening” expenses	0	34
	Subtotal		0	280
R&D expenses		* Developing eco-friendly products and related personnel expenses	5	93
Social activities expenses	“Greening” at other locations	* “Greening” expenses	0	0.7
	Contributions to environmental preservation organizations	* Contributions to environmental preservation organizations	0	0.3
	Subtotal		0	1
Environmental damage expenses		* Environmental damage restoration expenses	0	0
Grand Total			327	1,142

The figures in parentheses on the right are the grand totals for FY 2000.

(517)

(1,232)

Benefits of Environmental Preservation Activities for FY 2001

(Economic effects)

(Millions of yen)

(Quantitative effects)

Type of effect	Major activities	Amount	Type of effect	Environmental impact for FY 2001	Environmental impact for FY 2000
Expenses reduced through energy conservation	* Introduction of energy-saving equipment * Use of fuel conversion	55	Reduction of use of styrofoam	64% reduction from FY 1999 level	30% reduction
Expenses reduced through resource conservation	* Separation of metal scrap	43	Conservation of resources through increased use of returnable boxes for purchased parts	91% usage ratio	85%
Waste-disposal expenses reduced through recycling	* Introduction of grinding swarf briquetters * Use of oil/water separation devices	33	Replacement of Halon fire extinguishers with carbon-gas fire extinguishers	221 extinguishers replaced (target: 175)	357 replaced
Total		131			

The figure in parentheses on the right is total for FY 2000.

(185)

▶ 5. Introduction of Non-coniferous Packaging Materials and Compliance with New EU Regulations

To contribute to global pest management, in September 2001 NTN began using packaging materials that conform to notifications banning the use of coniferous packaging materials for products shipped to China and the EU.

In response to the End of Life Vehicles

Directive, which establishes mandatory parts recycling rates and prohibits the use of automotive parts containing the toxic metals lead, cadmium, mercury or hexavalent chrome for automobiles sold in the EU beginning July 1, 2003, NTN began inspecting all relevant parts

and performing evaluation testing for alternative parts in fiscal 2001. During fiscal 2002, we will begin the construction of systems required for the switchover to alternative parts and the gradual shifting to the use of these parts.

Financial Review

Net sales

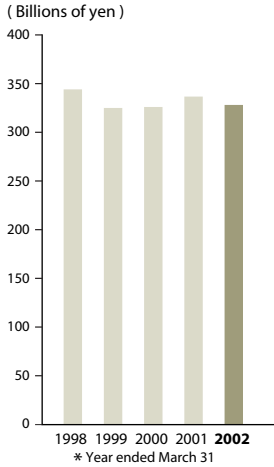

Sales by business segment

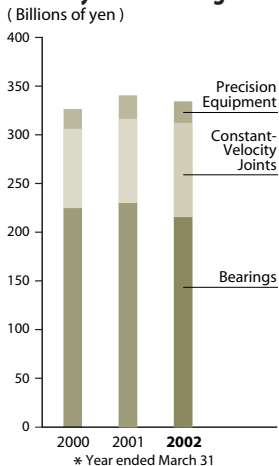

Sales by region

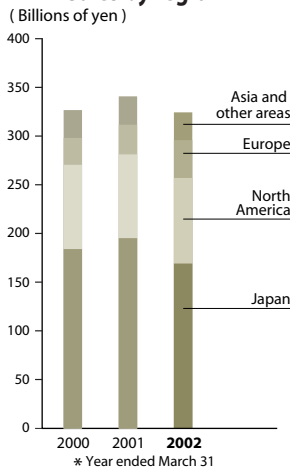

Sales and Income

Results of Sales

Sales for the fiscal year ended March 31, 2002 were ¥324,339 million, a decrease of 4.8% or ¥16,212 million from the previous year.

Sales by Business Segment

Despite an increase in sales to auto manufacturers in Europe, sales of bearings fell to ¥215,558 million, a decrease of 6.3%, or ¥14,459 million from the previous fiscal year. Sales in Japan decreased due to production cutbacks in the general machinery industry and inventory adjustments by distributors and users. Weakened demand led to lower sales, especially in the general machinery industry in North America.

Constant-velocity joint (CVJ) sales, meanwhile, rose by ¥467 million, or 0.5%, to ¥86,785 million. Although sales in Japan were adversely affected by in-house production among auto manufacturers and intense price competition, growing production of CVJs in Europe and a healthy demand in North America helped to bolster overall sales.

Although a new mechanical clutch unit was successfully marketed in Japan during the fiscal year, sales of precision equipment fell by 9.2%, or ¥2,220 million, to ¥21,996 million. This was due to a decrease in capital expenditures in the IT industry, which caused a drop in demand for LCD repair devices and parts feeders.

Sales by Region

The continued stagnant economy and increased price competitiveness in Japan during the fiscal year adversely affected sales of CVJs and other automotive products as well as sales to general machinery manufacturers and distributors, resulting in overall sales in Japan of ¥169,080 million, down 13.4%, or ¥26,054 million.

Sales in North America, however, rose by 2.2% (¥1,849 million) to ¥87,774 million over the previous fiscal year. This was due to the weakening of the yen, although declining demand in North America resulted in a lower volume of sales to the automotive and general machinery sectors.

An increase in the manufacture of CVJs at NTN Transmissions Europe, which began operations during the latter half of last year, in addition to stronger sales to the automotive sector and a weakening of the yen, led to a 27.3% (¥8,299 million) jump in European sales over the previous fiscal year to ¥38,748 million.

Despite the weakening of the yen and an increase in locally manufactured products in Thailand, the continued stagnant economic conditions of the ASEAN countries contributed to lower sales in Asia, which fell 1.1%, or ¥306 million, to ¥28,737 million.

Cost of Sales and Selling, General and Administrative Expenses

Although cost of sales declined 4.3%, or ¥11,931 million, from the previous fiscal year to ¥266,337 million, the percentage of cost to overall sales deteriorated 0.4% to 82.1%. This can be attributed to lower sales and curtailed production to control inventory as well as to lowered sales prices resulting from fiercer competition. This is despite the effect of the weakening yen and reductions in the cost of raw materials, subcontractor expenses and personnel costs. Selling, general and administrative expenses totaled ¥49,862 million, a rise of 4.0%, or ¥1,914 million, and the percentage of cost to overall sales deteriorated 1.3% to 15.4%.

Income

Operating income for the previous fiscal year decreased 43.2%, or ¥6,195 million, to ¥8,140 million, and operating margins fell from 4.2% to 2.5% due to an increase in the ratios of selling, general and administrative expenses and cost of sales to net sales.

With regard to other non-operating income and expenses, the Company posted a loss of ¥8,841 million. Income totaled ¥4,284 million and included ¥3,233 million in gains on the sale of a plant site and other fixed assets and ¥719 million equity in earnings. Expenses totaled ¥13,125 million and included ¥3,377 million as a loss on write-down of investments in securities, ¥1,790 million in payments of antidumping duties for prior periods, ¥814 million as a loss in liquidation of consolidated subsidiaries (NTN Precision Forging Co., Ltd.), and ¥643 million as a provision of allowance for doubtful accounts. Interest expenses decreased from the previous year, due to reduced borrowing, to ¥4,185 million. This fiscal year's net loss for other non-operating income and expenses increased ¥1,394 million over the previous year, when NTN posted a loss in this category of ¥7,447 million, which was due primarily to the offset of the costs in adopting new accounting standards for retirement benefits and gains on securities contributions to an employee retirement benefit trust.

Overall, NTN reported a net loss before income taxes and minority interests of ¥701 million, compared to a ¥6,888 million gain the previous year. Net loss was ¥132 million, compared to a ¥4,289 million profit in the prior year, and net loss per share for the fiscal year was ¥0.29.

R&D and Capital Expenditures

Research and Development

Expenditures for research and development for the fiscal year totaled ¥11,706 million, an increase of 10.2% or ¥1,088 million. As a share of net sales, R&D expense rose to 3.6%. R&D expenses by business segment were as follows: ¥6,690 million for bearings, ¥3,186 million for CVJs, and ¥1,830 million for precision equipment.

Capital Expenditures

During the fiscal year, capital spending was used to increase production capacity, implement labor savings and rationalization, maintain and upgrade present facilities, enhance the safety of those facilities, and provide equipment for new product R&D. Capital investment decreased by ¥3,035 million, or 12.6%, from the previous year to ¥21,088 million.

Investments in the bearing segment totaled ¥11,964 million and included new equipment for the manufacture of third-generation hub bearings at American NTN Bearing Mfg. Corp., new equipment for the manufacture of radial ball bearings at NTN Bearing Corp. of Canada Ltd., Iwata Works' Needle Roller Bearing Plant and Kuwana Works. Meanwhile, the Company spent ¥8,154 million on capital investment for CVJs, including the introduction of new manufacturing equipment at NTN Transmissions Europe, Iwata Works' CVJ Plant and NTN Driveshaft Inc. With regard to precision equipment, ¥970 million was invested primarily to enhance the ball screw manufacturing facilities at Nagano Works. All expenditures were funded in cash, with depreciation for the year amounting to ¥24,400 million.

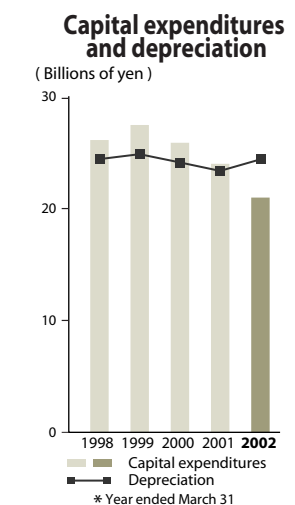
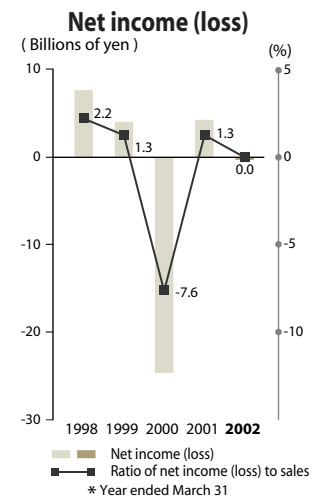
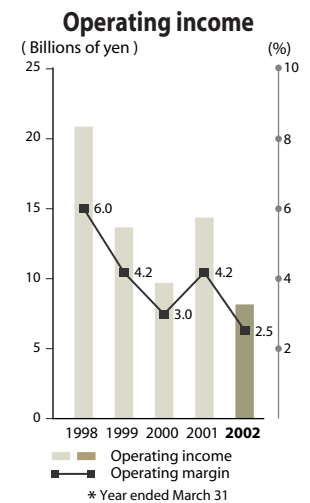

Financial Position and Cash Flows

Inventories

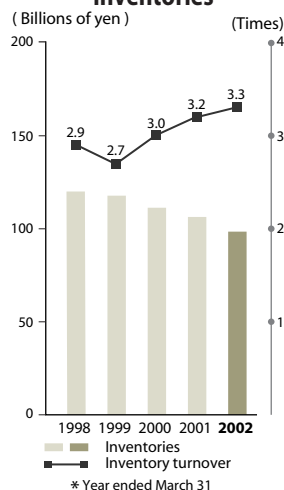

Interest-bearing debt

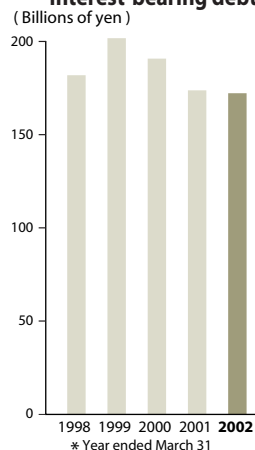

Financial Position

Total assets at year-end decreased by ¥16,050 million from the previous year to ¥462,895 million. The turnover ratio of total assets decreased slightly to 0.70, down 0.01 from the previous year.

Total current assets at year-end came to ¥229,477 million, a decrease of ¥16,881 million. As a result of decreased sales, trade notes and receivables were down by ¥11,571 million.

Inventories declined by ¥7,896 million as a result of continuing control measures, and excluding the effect of foreign currency exchange rates, an actual reduction of ¥9,817 million was achieved. The inventory turnover ratio for the year improved slightly to 3.29, up 0.09 from the previous year. Current liabilities at year-end declined by ¥15,938 million to ¥173,431 million. Notes and accounts payable decreased by ¥9,623 million and accrued income taxes fell by ¥3,840 million. As a result, net working capital declined by ¥943 million to ¥56,046 million, and the liquidity ratio rose 2% from the previous year to 132%.

Interest-bearing debt declined by ¥1,163 million also as a result of continuing control measures, and excluding the effect of foreign currency exchange rates, interest-bearing debt actually decreased by ¥5,176 million. The interest-bearing debt-to-total assets ratio at year-end deteriorated to 37.3%, a 1.0% increase from the previous year.

During the fiscal year, shareholders' equity decreased by ¥93 million to ¥138,532 million despite the increase of ¥3,989 million in the adjustment of foreign currency. This was due to a decrease of ¥3,050 million in consolidated retained earnings and a decrease of ¥1,019 million in net unrealized holding gains on securities. The shareholders' equity ratio was 29.9%, representing an increase of 1.0% from the previous fiscal year.

Cash Flows

The net cash from operations during the fiscal year amounted to ¥30,034 million, compared to a decrease of ¥6,214 million, or 17.1%, during the previous fiscal year. Of this amount, ¥24,400 million was depreciation, ¥12,659 million was a decrease in trade receivables, and ¥9,841 million was a decrease in inventories. Meanwhile, trade payables decreased ¥9,986 million and ¥7,979 million was paid in income tax.

The net cash used in investing activities was ¥18,355 million, an increase of ¥8,255 million, or 81.7%, compared to fiscal 2000. The Company used ¥21,021 million for the acquisition of fixed tangible assets, while proceeds from the sale of fixed tangible assets was ¥3,722 million.

The net cash used in financing activities totaled ¥7,965 million, a decrease of ¥18,908 million, or 70.4%, from the previous fiscal year. Net base short- and long-term loans decreased ¥5,170 million and ¥2,778 million was paid in dividends.

After adjusting for ¥1,183 million for the effect of exchange rate changes, cash and cash equivalents amounted to ¥36,072 million, representing an increase of ¥2,531 million, or 7.5%, from the previous fiscal year.

Five-Year Summary of Selected Financial Data

NTN CORPORATION and consolidated subsidiaries
Year ended March 31

	Millions of yen except per share amounts					Thousands of U.S. dollars except per share amounts
	2002	2001	2000	1999	1998	2002
FOR THE YEAR DATA						
Net sales	¥ 324,339	¥ 340,551	¥ 326,474	¥ 325,812	¥ 347,919	\$ 2,434,064
Operating income	8,140	14,335	9,675	13,633	20,816	61,088
Income (loss) before income taxes *	(701)	6,888	(41,822)	9,726	14,144	(5,260)
Net income (loss)	(132)	4,289	(24,677)	4,067	7,690	(991)
Capital expenditures	21,088	24,123	26,013	27,609	26,265	158,259
Depreciation	24,400	23,402	24,122	24,835	24,411	183,114
R&D expenditures	11,706	10,618	9,779	9,274	9,015	87,850

AT YEAR-END DATA

Total assets	¥ 462,895	¥ 478,945	¥ 494,677	¥ 487,477	¥ 473,320	\$ 3,473,884
Shareholders' equity	138,532	138,625	143,874	171,969	172,046	1,039,640
Number of employees	11,989	12,619	12,770	12,554	12,675	11,989

PER SHARE DATA

Shareholders' equity	¥ 299.27	¥ 299.44	¥ 310.77	¥ 371.39	¥ 371.55	\$ 2.25
Net income (loss)						
-Basic	(0.29)	9.26	(53.30)	8.78	16.61	(0.00)
-Diluted	—	8.78	—	8.31	15.44	—
Cash dividends	5.50	6.00	6.50	8.00	9.00	0.04

OTHER INFORMATION

Net income (loss) / Total assets (ROA) ...	(0.03%)	0.9%	(5.0%)	0.8%	1.6%	(0.03%)
Net income (loss) / Shareholders' equity (ROE) ..	(0.1%)	3.0%	(15.6%)	2.4%	4.5%	(0.1%)
Shareholders' equity ratio	29.9%	28.9%	29.1%	35.3%	36.3%	29.9%

* Income (loss) before income taxes and minority interests

	Millions of yen		Thousands of U.S. dollars
	2002	2001	2002

SEGMENT INFORMATION

By business

Bearings	¥ 215,558	¥ 230,017	¥ 224,819	\$ 1,617,696
CVJs	86,785	86,318	81,382	651,295
Precision equipment	21,996	24,216	20,273	165,073

By region

Japan	¥ 169,080	¥ 195,134	¥ 183,936	\$ 1,268,893
North America	87,774	85,925	86,399	658,717
Europe	38,748	30,449	27,602	290,792
Asia and others areas	28,737	29,043	28,537	215,662

Notes: 1) U.S. dollar amounts have been translated from yen, for convenience only, using the approximate exchange rate at March 31, 2002, which was U.S.\$1 = ¥133.25.

Consolidated Balance Sheets

NTN CORPORATION and consolidated subsidiaries
March 31, 2002 and 2001

ASSETS	Millions of yen		Thousands of U.S.dollars (Note 1)
	2002	2001	2002
Current assets:			
Cash and cash equivalents	¥ 36,072	¥ 33,541	\$ 270,709
Short-term investments (Note 2 (d) and 3)	102	261	765
Trade receivables			
Notes	16,982	23,063	127,445
Accounts	66,301	71,842	497,569
Allowance for doubtful accounts	(17)	(68)	(128)
Total	83,266	94,837	624,886
Inventories (Note 4)	98,513	106,409	739,310
Deferred income taxes (Note 12)	4,778	4,454	35,857
Other current assets	6,746	6,856	50,627
Total current assets	229,477	246,358	1,722,154
Property, plant and equipment (Note 5):			
Land	21,559	21,426	161,794
Buildings and structures (Note 2 (f))	109,838	107,875	824,300
Machinery and equipment	430,769	413,717	3,232,788
Construction in progress	4,072	6,957	30,559
	566,238	549,975	4,249,441
Less accumulated depreciation	(387,770)	(371,036)	(2,910,094)
Net property, plant and equipment	178,468	178,939	1,339,347
Investments and other assets:			
Investment securities (Note 2 (d) and 3)	14,535	19,790	109,081
Stock investments in non-consolidated subsidiaries and affiliates	8,679	6,950	65,133
Deferred income taxes (Note 12)	27,723	22,294	208,053
Other assets	4,013	4,614	30,116
Total investments and other assets	54,950	53,648	412,383
	¥ 462,895	¥ 478,945	\$ 3,473,884

See accompanying notes to the consolidated financial statements

N
O
T
A
R
I
A
L
C
O
R
P
O
R
A
T
I
O
N

LIABILITIES AND SHAREHOLDERS' EQUITY	Millions of yen		Thousands of U.S.dollars (Note 1)
	2002	2001	2002
Current liabilities:			
Short-term bank loans (Note 5)	¥ 92,416	¥ 94,451	\$ 693,553
Current portion of long-term debt (Note 5)	2,248	1,396	16,871
Trade payables			
Notes	21,217	27,181	159,227
Accounts	31,993	35,652	240,098
Total	53,210	62,833	399,325
Accrued income taxes (Note 12)	1,808	5,648	13,568
Deferred income taxes (Note 12)	68	46	510
Other current liabilities	23,681	24,995	177,719
Total current liabilities	173,431	189,369	1,301,546
Long-term liabilities:			
Long-term debt (Note 5)	77,924	77,904	584,795
Accrued retirement benefits to employees (Note 2 (g) and 6)	67,044	67,361	503,144
Accrued retirement benefits to directors and statutory auditors (Note 2 (h))	491	696	3,685
Deferred income taxes (Note 12)	3,089	2,738	23,182
Other long-term liabilities	767	784	5,757
Total long-term liabilities	149,315	149,483	1,120,563
Minority interests	1,617	1,468	12,135
Shareholders' equity (Note 10):			
Common stock			
Authorized 800,000,000 shares			
Issued - 463,056,775 shares			
(463,056,775 shares in 2001)	39,599	39,599	297,178
Capital surplus	52,622	52,622	394,912
Retained earnings	50,409	53,459	378,304
Net unrealized holding gains on securities	1,425	2,444	10,694
Foreign statement translation adjustments	(5,435)	(9,424)	(40,788)
Less: cost of treasury stock	(88)	(75)	(660)
Total shareholders' equity	138,532	138,625	1,039,640
Contingencies (Note 7)			
	¥ 462,895	¥ 478,945	\$ 3,473,884

Consolidated Statements of Income

NTN CORPORATION and consolidated subsidiaries
Years ended March 31, 2002 and 2001

	Millions of yen		Thousands of U.S.dollars (Note 1)
	2002	2001	2002
Net sales	¥ 324,339	¥ 340,551	\$ 2,434,064
Cost of sales (Note 11)	266,337	278,268	1,998,777
Gross profit	58,002	62,283	435,287
Selling, general and administrative expenses (Note 11)	49,862	47,948	374,199
Operating income	8,140	14,335	61,088
Other income (expenses):			
Interest and dividend income	332	669	2,492
Interest expenses	(4,185)	(5,129)	(31,407)
Equity in earnings of affiliates	719	769	5,396
Gain on sale of property, plant and equipment	3,233	878	24,263
Payments of antidumping duties for prior periods	(1,790)	—	(13,433)
Loss on liquidation of a consolidated subsidiary	(814)	—	(6,109)
Provision of allowance for doubtful accounts	(643)	—	(4,826)
Loss on write-down of investment securities	(3,377)	—	(25,343)
Gain on securities contribution to employee retirement benefit trust	—	10,078	—
Costs related to adopting new accounting standards for retirement benefit (Note 2 (g) and 6)	—	(12,848)	—
Other, net	(2,316)	(1,864)	(17,381)
Total	(8,841)	(7,447)	(66,348)
Income (loss) before income taxes and minority interests	(701)	6,888	(5,260)
Income taxes (Note 12):			
Current	3,427	5,687	25,719
Deferred	(4,005)	(3,016)	(30,056)
Total	(578)	2,671	(4,337)
Income (loss) before minority interests	(123)	4,217	(923)
Minority interests in subsidiaries	(9)	72	(68)
Net income (loss)	¥ (132)	¥ 4,289	\$ (991)
		Yen	U.S.dollars (Note 1)
Net income (loss) per share (Note 2 (I)):			
Basic	¥ (0.29)	¥ 9.26	\$ (0.00)
Diluted	—	8.78	—
Cash dividends per share (Note 2 (I))	5.50	6.00	0.04

See accompanying notes to the consolidated financial statements

Consolidated Statements of Shareholders' Equity

NTN CORPORATION and consolidated subsidiaries
Years ended March 31, 2002 and 2001

	Millions of yen		Thousands of U.S.dollars (Note 1)
	2002	2001	2002
Common stock:			
Balance at beginning of the year	¥ 39,599	¥ 39,599	\$ 297,178
Balance at end of the year	¥ 39,599	¥ 39,599	\$ 297,178
Capital surplus:			
Balance at beginning of the year	¥ 52,622	¥ 52,622	\$ 394,912
Balance at end of the year	¥ 52,622	¥ 52,622	\$ 394,912
Retained earnings:			
Balance at beginning of the year :			
Unappropriated	¥ 53,459	¥ 51,727	\$ 401,193
Increase in retained earnings in an affiliate which was newly accounted for by the equity method	—	251	—
Net income (loss)	(132)	4,289	(991)
Appropriation:			
Cash dividends	(2,778)	(2,778)	(20,848)
Bonuses to directors and statutory auditors	(140)	(30)	(1,050)
Balance at end of the year	¥ 50,409	¥ 53,459	\$ 378,304
Net unrealized holding gains on securities:			
Balance at beginning of the year	¥ 2,444	¥ —	\$ 18,341
Increase (decrease)	(1,019)	2,444	(7,647)
Balance at end of the year	¥ 1,425	¥ 2,444	\$ 10,694
Foreign statement translation adjustments:			
Balance at beginning of the year	¥ (9,424)	¥ —	\$ (70,724)
Decrease (increase)	3,989	(9,424)	29,936
Balance at end of the year	¥ (5,435)	¥ (9,424)	\$ (40,788)
Cost of treasury stock:			
Balance at beginning of the year	¥ (75)	¥ (74)	\$ (563)
Increase	(13)	(1)	(97)
Balance at end of the year	¥ (88)	¥ (75)	\$ (660)

See accompanying notes to the consolidated financial statements

Consolidated Statements of Cash Flows

NTN CORPORATION and consolidated subsidiaries
Years ended March 31, 2002 and 2001

	Millions of yen		Thousands of U.S.dollars (Note 1)
	2002	2001	2002
Cash flows from operating activities:			
Net income (loss) before income taxes and minority interests	¥ (701)	¥ 6,888	\$ (5,260)
Adjustments for:			
Depreciation	24,400	23,402	183,114
Increase in allowance for doubtful accounts	717	253	5,381
Increase (decrease) in accrued retirement benefits to employees	(386)	4,621	(2,897)
Increase (decrease) in accrued retirement benefits to directors and statutory auditors	(205)	69	(1,538)
Interest and dividend income	(332)	(669)	(2,492)
Interest expenses	4,185	5,129	31,407
Foreign statement translation adjustments	151	(1,649)	1,133
Equity in earnings of affiliates	(719)	(769)	(5,396)
Gain on sale of property, plant and equipment	(3,233)	(878)	(24,263)
Loss on sale of property, plant and equipment	698	—	5,238
Loss on write-down of investment securities	3,377	—	25,343
Decrease (increase) in trade receivables	12,659	(9,140)	95,002
Decrease in inventories	9,841	7,352	73,854
Increase (decrease) in trade payables	(9,986)	2,055	(74,942)
Payments of bonuses to directors and statutory auditors	(142)	(32)	(1,066)
Other	1,498	2,606	11,243
Sub total	41,822	39,238	313,861
Interest and dividend income received	868	1,071	6,514
Interest expenses paid	(4,677)	(5,174)	(35,099)
Income taxes refunded (paid)	(7,979)	1,113	(59,880)
Net cash provided by operating activities	30,034	36,248	225,396
Cash flows from investing activities:			
Decrease in short-term investments	159	12,955	1,193
Payments for purchase of property, plant and equipment	(21,021)	(22,602)	(157,756)
Proceeds from sale of property, plant and equipment	3,722	1,128	27,932
Payments for purchase of intangible fixed assets	(450)	(865)	(3,377)
Payments for investment in affiliates	(1,132)	(342)	(8,495)
Other	367	(374)	2,754
Net cash used in investing activities	(18,355)	(10,100)	(137,749)
Cash flows from financing activities:			
Decrease in short-term bank loans, net	(5,294)	(8,459)	(39,730)
Proceeds from long-term debt	2,503	6,197	18,784
Repayment of long-term debt, including current portion	(2,379)	(21,828)	(17,854)
Cash dividends paid	(2,778)	(2,778)	(20,848)
Other	(17)	(5)	(127)
Net cash used in financing activities	(7,965)	(26,873)	(59,775)
Effect of exchange rate changes on cash and cash equivalents	(1,183)	918	(8,878)
Net increase in cash and cash equivalents	2,531	193	18,994
Cash and cash equivalents at beginning of the year	33,541	33,348	251,715
Cash and cash equivalents at end of the year	¥ 36,072	¥ 33,541	\$ 270,709

See accompanying notes to the consolidated financial statements

Notes to the Consolidated Financial Statements

NTN CORPORATION and consolidated subsidiaries
March 31, 2002 and 2001

1. Basis of Presenting the Consolidated Financial Statements

NTN CORPORATION (the "Company") and its domestic subsidiaries maintain their accounts and records in accordance with the provisions set forth in the Commercial Code of Japan and the Securities and Exchange Law and in conformity with accounting principles and practices generally accepted in Japan, which may differ in some material respects from accounting principles and practices generally accepted in countries and jurisdictions other than Japan.

The Company's overseas subsidiaries maintain their accounts and records in conformity with generally accepted accounting principles and practices prevailing in their respective countries of domicile.

The accompanying consolidated financial statements are prepared based on the consolidated financial statements of the Company and its subsidiaries (the "Group") as required by the

Securities and Exchange Law.

In preparing the accompanying consolidated financial statements, certain reclassifications and rearrangements have been made to the consolidated financial statements issued domestically in order to present them in a form which is more familiar to readers outside Japan.

The translation of the Japanese yen amounts into U.S. dollars is included solely for the convenience of the reader, using the approximate exchange rate at March 31, 2002, which was ¥133.25 to US\$1.00. These translations have been made for the convenience of the reader, and should not be construed as representations that the Japanese yen amounts have been, or could be in the future, converted into U.S. dollars at this or any other rate of exchange.

2. Summary of Significant Accounting Policies

(a) Consolidation Principles

The consolidated financial statements include the accounts of the Company and significant subsidiaries. All significant inter-company transactions and accounts are eliminated in consolidation.

Investments in significant affiliates are accounted for by the equity method whereby the Group includes in net income its share of income or losses of these companies, and records its investments at cost adjusted for its share of income, losses or dividends received.

Investment in a certain affiliate, previously accounted for by the cost method, has been accounted for by the equity method from the fiscal year ended March 31, 2001 due to an increase in our ownership of that company.

(b) Translation of Foreign Currencies

Effective April 1, 2000, the Group adopted revised accounting standards for foreign currency transactions, which were issued by the Business Accounting Deliberation Council.

Monetary assets and liabilities denominated in foreign currencies are translated into yen at the rate of exchange in effect at the balance sheet dates. Up until March 31, 2000, long-term monetary assets and liabilities were translated at historical exchange rates. Revenues and expenses were, and still are, translated at the rates of exchange prevailing when transactions are made.

Assets and liabilities of foreign subsidiaries and affiliates are translated into Japanese yen at the exchange rates in effect on the respective balance sheet dates, and shareholders' equity is at the historical rates. Revenue and expenses are translated at the average rates of exchange for the respective years. Differences arising from translation are presented as "Foreign statement translation adjustments" in the accompanying consolidated balance sheets.

Up until March 31, 2000, foreign statement translation

adjustments were reflected in assets or liabilities on the consolidated balance sheets. Under the new method, foreign statement translation adjustments are reflected in shareholders' equity and minority interests on the consolidated balance sheet at March 31, 2001.

(c) Consolidated Statement of Cash Flows

For the purposes of the consolidated statements of cash flows, the Company considers all highly liquid investments, which are readily convertible into cash and / or mature within three months or less, to be cash equivalents.

(d) Short-term Investments and Investment Securities

Up until March 31, 2000, marketable securities included in short-term investments and investment securities were stated at the lower of cost or market. Other investments are stated at cost. The cost is determined by the moving average method.

Effective April 1, 2000, the Group adopted new accounting standards for financial instruments, which were issued by the Business Accounting Deliberation Council. In accordance with the new standards, securities are classified into four categories: trading securities, held-to-maturity securities, stock investments in subsidiaries and affiliates, and securities available for sale. Except for stock investments in subsidiaries and affiliates, the securities owned by the Group are all securities available for sale.

Marketable securities available for sale are carried at fair value with the unrealized gains and losses, net of tax, reported on a separate line within shareholders' equity. Under the Commercial Code, unrealized holding gains on securities, net of related taxes is not available for distribution as dividends and bonuses to directors and statutory auditors. Declines in value on the securities judged to be other than temporary are charged to income.

Non-marketable securities available for sale are carried at cost. Marketable securities in the amount of ¥18,127 million classified as short-term investments up until March 31, 2000 were transferred to investment securities.

(e) Inventories

Inventories are principally stated at cost, determined by the average method.

(f) Property, Plant and Equipment

Property, plant and equipment are stated at cost. Depreciation is computed at rates based on the estimated useful lives of assets using the declining-balance method, except for buildings and assets of the overseas consolidated subsidiaries, for which the straight-line method is applied.

The principal estimated useful lives are as follows:

Buildings and structures	10 to 50 years
Machinery and equipment	5 to 12 years

(g) Accrued Retirement Benefits to Employees

The Company and certain consolidated subsidiaries principally have a lump-sum benefit plan generally covering all employees. Under the terms of the retirement plan of the Group, substantially all employees are eligible to a lump-sum payment at the time of retirement. The amount of retirement benefit is, in general, determined on the basis of length of service, basic salary at the time of retirement and conditions under which the retirement occurs.

Up until March 31, 2000, the Group principally provided for employees' retirement benefits, at the full amount which would be required if all eligible employees voluntarily retire as of the balance sheet date.

Effective April 1, 2000, the Group adopted new accounting standards for retirement benefit, which were issued by the Business Accounting Deliberation Council. In accordance with the new standards, accrued retirement benefits to employees is provided based on the amount of projected benefit obligation reduced by pension plan assets at fair value at balance sheet dates. Costs related to the adoption of the new accounting standards amounting to ¥12,848 million was wholly amortized for the year ended March 31, 2001. As a result, periodic benefit cost increased by ¥1,220 million and income before income taxes and minority interests decreased by ¥3,827 million for the year ended March 31, 2001.

(h) Accrued Retirement Benefits to Directors and Statutory Auditors

Retirement benefits to directors and statutory auditors of the Company and certain of its domestic subsidiaries are provided based on their pertinent rules and are calculated as the estimated amount which would be payable if all officers retired at the balance sheet dates. Any amounts payable to directors and statutory auditors upon retirement are subject to approval at the shareholders' meeting.

(i) Leases

The finance leases without covenants transferring ownership of the properties to lessees are not capitalized, and accounted for by a method applicable to operating leases

(j) Research and Development Cost and Computer Software

Research and development cost is charged to income when incurred.

Costs relating to computer software developed for internal use is charged to income when incurred, except if it contributes to the generation of income or to cost savings. Such cost is capitalized as an asset and amortized using the straight-line method over its estimated useful life of 5 years.

(k) Income Taxes

Income taxes are based on taxable income and charged to income on an accrual basis. Deferred income taxes relating to timing differences between financial and income tax reporting are provided.

(l) Net Income (Loss) and Cash Dividends Per Share

The computation of primary net income (loss) and cash dividends per share of common stock are based on the weighted average number of shares outstanding each year.

Net income (loss) per share assuming full dilution is computed on the basis that all convertible bonds were converted into common stock at the beginning of each year or at the date of issue, with appropriate adjustment of related interest and other expenses, net of taxes, for such convertible bonds.

The diluted amount per share is not presented for 2002, since a net loss was recorded for the year.

Cash dividends per share represent the cash dividends proposed by the Board of Directors as applicable to the respective years together with the interim cash dividends paid.

(m) Derivative Financial Instruments and Hedging Activities

Effective April 1, 2000, the Group adopted new accounting standards for financial instruments (see (d)). All derivatives are stated at fair value with changes in fair value included in net profit or loss for the period in which they arise, except for derivatives that are designated as "hedging instruments".

Derivative financial instruments are utilized by the Group principally to reduce interest rate and foreign exchange rate risks, and they are comprised of interest rate swap agreements and forward exchange contracts. The Group has established a control environment which includes policies and procedures for risk assessment and for the approval, reporting and monitoring of transactions involving derivative financial instruments. The Group does not hold or issue derivative financial instruments for speculation.

The Group is exposed to certain market risks arising from its forward exchange contracts and swap agreements. The Group is also exposed to the risk of credit loss in the event of non-performance by the counterparties with respect to currency and interest; however, the Group does not anticipate non-performance by any of these counterparties all of whom are financial institutions with high credit ratings.

At March 31, 2002 and 2001, all derivative financial instruments utilized by the Group met the criteria for hedge accounting.

(n) Appropriation of Retained Earnings

Cash dividends and bonuses to directors and statutory auditors are recorded in the fiscal year in which a proposed appropriation is approved by the shareholders' meeting.

3. Short-term Investments, Investment Securities

At March 31, 2002 and 2001, short-term investments and investment securities were as follows:

Millions of yen				
2002				
	Cost	Gross unrealized gains	Gross unrealized losses	Book value (Estimated fair value)
Short-term Investments:				
Market value not available	¥ 102			
Investment Securities:				
Market value available:				
Stock securities	¥ 10,574	¥ 2,913	¥ 469	¥ 13,018
Other securities	47	—	15	32
	<u>¥ 10,621</u>	<u>¥ 2,913</u>	<u>¥ 484</u>	<u>¥ 13,050</u>
Market value not available:	<u>¥ 1,485</u>			

Millions of yen				
2001				
	Cost	Gross unrealized gains	Gross unrealized losses	Book value (Estimated fair value)
Short-term Investments:				
Market value not available	¥ 261			
Investment Securities:				
Market value available:				
Stock securities	¥ 13,949	¥ 4,677	¥ 498	¥ 18,128
Other securities	47	—	13	34
	<u>¥ 13,996</u>	<u>¥ 4,677</u>	<u>¥ 511</u>	<u>¥ 18,162</u>
Market value not available:	<u>¥ 1,628</u>			

Thousands of U.S.dollars				
2002				
	Cost	Gross unrealized gains	Gross unrealized losses	Book value (Estimated fair value)
Short-term Investments:				
Market value not available	\$ 765			
Investment Securities:				
Market value available:				
Stock securities	\$ 79,354	\$ 21,861	\$ 3,519	\$ 97,696
Other securities	353	—	113	240
	<u>\$ 79,707</u>	<u>\$ 21,861</u>	<u>\$ 3,632</u>	<u>\$ 97,936</u>
Market value not available:	<u>\$ 11,145</u>			

4. Inventories

Inventories as of March 31, 2002 and 2001 were comprised of the following:

	Millions of yen		Thousands of U.S.dollars
	2002	2001	2002
Finished goods	¥ 57,820	¥ 63,266	\$ 433,921
Work in process and raw materials	40,693	43,143	305,389
	<u>¥ 98,513</u>	<u>¥ 106,409</u>	<u>\$ 739,310</u>

5. Short-term Bank Loans and Long-term Debt

Short-term bank loans outstanding are generally represented by unsecured short-term notes and bore interest at an annual average rate of 2.1% and 3.7% in 2002 and 2001, respectively.

Long-term debt at March 31, 2002 and 2001 consisted of:

	Millions of yen		Thousands of U.S.dollars
	2002	2001	2002
Banks and insurance companies, Maturing serially through 2007	¥ 10,172	¥ 9,300	\$ 76,337
0.85% Unsecured convertible bonds in Japanese yen due 2004	30,000	30,000	225,141
1.85% Unsecured bonds in Japanese yen due 2003	20,000	20,000	150,094
2.14% Unsecured bonds in Japanese yen due 2006	10,000	10,000	75,047
2.7% Unsecured bonds in Japanese yen due 2009	10,000	10,000	75,047
	<u>80,172</u>	<u>79,300</u>	<u>601,666</u>
Less amounts due within one year	<u>(2,248)</u>	<u>(1,396)</u>	<u>(16,871)</u>
	<u>¥ 77,924</u>	<u>¥ 77,904</u>	<u>\$ 584,795</u>

Convertible bonds due 2004 are convertible into shares of common stock of the Company at ¥687 (\$ 5.16) per share.

As of March 31, 2002, ¥1,582 million (\$11,872 thousand) of property, plant and equipment were pledged as collateral for long-term debt of ¥505 million (\$3,790 thousand) and short-term bank loans and current portion of long-term debt of ¥2,308 million (\$17,321 thousand).

The aggregated annual maturities of long-term debt as of March 31, 2002 were as follows:

Year ending March 31	Millions of yen	Thousands of U.S.dollars
2003	¥ 2,248	\$ 16,871
2004	51,830	388,968
2005	1,457	10,934
2006	3,254	24,420
2007 and after	21,383	160,473
	<u>¥ 80,172</u>	<u>\$ 601,666</u>

6. Accrued Retirement Benefits to Employees

The following tables set forth the changes in benefit obligation, plan assets and funded status of the Group at March 31, 2002 and 2001:

	Millions of yen		Thousands of U.S.dollars
	2002	2001	2002
Benefit obligation at end of year	¥ (176,144)	¥ (164,332)	\$ (1,321,906)
Fair value of plan assets at end of year	<u>92,637</u>	<u>86,254</u>	<u>695,212</u>
Funded status:			
Benefit obligation in excess of plan assets	(83,507)	(78,078)	(626,694)
Unrecognized actuarial loss	19,917	10,717	149,471
Unrecognized prior service cost	(3,454)	—	(25,921)
Accrued retirement benefits to employees	<u>¥ (67,044)</u>	<u>¥ (67,361)</u>	<u>\$ (503,144)</u>

Severance and pension costs of the Group included the following components for the years ended March 31, 2002 and 2001:

	Millions of yen		Thousands of U.S.dollars
	2002	2001	2002
Service cost	¥ 5,412	¥ 5,177	\$ 40,615
Interest cost	6,280	5,428	47,129
Expected return on plan assets	(3,518)	(2,826)	(26,401)
Amortization:			
Costs related to adopting new accounting standards for retirement benefit	—	12,848	—
Actuarial loss	842	—	6,319
Prior service cost	(216)	—	(1,621)
Benefit cost	<u>¥ (8,800)</u>	<u>¥ (20,627)</u>	<u>\$ (66,041)</u>

Assumption used in the accounting for the defined benefit plans for the years ended March 31, 2002 and 2001 were as follows:

	2002	2001
Discount rate	mainly 3.5%	3.5%
Long-term rate of return on fund assets	mainly 4.0%	4.0%
Method of attributing benefit to periods of service	straight-line basis	straight-line basis
Amortization period for prior service cost	mainly 15 years	—
Amortization period for actuarial gains and losses(in and after the next financial year)	mainly 15 years	15 years
Amortization period for costs related to adopting new accounting standards for retirement benefit ...	—	1 year

7. Contingencies

At March 31, 2002 and 2001, contingent liabilities of the Group amounted to:

	Millions of yen		Thousands of U.S.dollars
	2002	2001	2002
Notes discounted or endorsed	¥ <u>1,353</u>	¥ <u>1,168</u>	\$ <u>10,154</u>

8. Finance Leases without Covenants Transferring Ownership of the Properties to Lessees

a) Information as a lessee

Properties which were leased under finance leases but which were not capitalized as of March 31, 2002 and 2001, were as follows:

	Millions of yen		Thousands of U.S.dollars
	2002	2001	2002
Acquisition cost	¥ <u>5,354</u>	¥ <u>5,621</u>	\$ <u>40,180</u>
Accumulated depreciation	¥ <u>(3,164)</u>	¥ <u>(2,823)</u>	\$ <u>(23,745)</u>
Net leased property	¥ <u>2,190</u>	¥ <u>2,798</u>	\$ <u>16,435</u>

Future minimum lease payments under finance leases as of March 31, 2002 and 2001 were as follows:

	Millions of yen		Thousands of U.S.dollars
	2002	2001	2002
Due within one year	¥ <u>549</u>	¥ <u>669</u>	\$ <u>4,120</u>
Due after one year	¥ <u>1,641</u>	¥ <u>2,129</u>	\$ <u>12,315</u>
Total	¥ <u>2,190</u>	¥ <u>2,798</u>	\$ <u>16,435</u>

The acquisition costs and future minimum lease payments under finance leases include the imputed interest expense portion.

Total lease payments under finance leases were ¥678 million (\$5,088 thousand) and ¥692 million for the years ended March 31, 2002 and 2001, respectively.

(b) Information as a lessor

Property, plant and equipment under the above kind of finance leases as of March 31, 2002 and 2001, were as follows:

	Millions of yen		Thousands of U.S.dollars
	2002	2001	2002
Machinery and equipment			
Acquisition cost	¥ <u>69</u>	¥ <u>72</u>	\$ <u>518</u>
Accumulated depreciation	¥ <u>(58)</u>	¥ <u>(51)</u>	\$ <u>(435)</u>
Net leased property	¥ <u>11</u>	¥ <u>21</u>	\$ <u>83</u>

Lease income for the years ended March 31, 2002 and 2001 amounted to ¥8 million (\$60 thousand) and ¥9 million, respectively.

Depreciation expense for the years ended March 31, 2002 and 2001 amounted to ¥3 million (\$23 thousand), and ¥5 million, respectively.

Future minimum lease receipts as of March 31, 2002 and 2001 were as follows:

	Millions of yen		Thousands of U.S.dollars
	2002	2001	2002
Within one year	¥ <u>6</u>	¥ <u>9</u>	\$ <u>45</u>
After one year	¥ <u>25</u>	¥ <u>20</u>	\$ <u>188</u>
Total	¥ <u>31</u>	¥ <u>29</u>	\$ <u>233</u>

The imputed interest portion is included in the above amounts.

9. Operating leases

Obligations under non-cancelable operating leases as of March 31, 2002 and 2001 were as follows:

	Millions of yen		Thousands of U.S.dollars
	2002	2001	2002
Due within one year	¥ <u>172</u>	¥ <u>172</u>	\$ <u>1,291</u>
Due after one year	¥ <u>870</u>	¥ <u>1,051</u>	\$ <u>6,529</u>
Total	¥ <u>1,042</u>	¥ <u>1,223</u>	\$ <u>7,820</u>

10. Shareholders' Equity

The Commercial Code of Japan requires that an amount not less than 10 percent of cash dividends and bonuses to directors and statutory auditors shall be appropriated as a legal reserve. Under the revised Commercial Code of Japan effective from October 1, 2001, when the total balance of legal reserve and capital surplus is not less than 25 percent of common stock, a company may not appropriate retained earnings to the legal reserve. The legal reserve is not available for dividends but may be used to reduce a deficit or may be transferred to common stock. Amounts of legal reserve and

capital surplus in excess of 25 percent of common stock are available for distribution upon approval of the shareholders' meeting.

Legal reserve of the Company, included in retained earnings as of March 31, 2002 and 2001, amounted to ¥8,639 million (\$ 64,833 thousand) and ¥8,456 million, respectively.

At the shareholders' meeting held on June 27, 2002, it was approved that the Company may purchase the treasury stock, up to a maximum of 15,000,000 shares, by using the Company's retained earnings.

11. Research and Development Cost

Research and development costs included in cost of sales and selling, general and administrative expenses were ¥11,706 million

(\$ 87,850 thousand) and ¥10,618 million for the years ended March 31, 2002 and 2001, respectively.

12. Income Taxes

The Company and its domestic subsidiaries are subject to several taxes based on income, which in the aggregate resulted in statutory tax rates of 41.3% for the years ended March 31, 2002 and 2001. Overseas subsidiaries are subject to income taxes of the

countries in which they operate.

Information explaining the difference between the effective tax rate and the Company's statutory rate for the year ended March 31, 2002 is not presented since a net loss was recorded for the year.

The effective rate for the year ended March 31, 2001 differs from the Company's statutory tax rate for the following reasons:

Statutory tax rate	41.3%
Expenses not deductible for income tax purposes	1.6
Revenues deductible for income tax purposes	(5.9)
Elimination of dividends received	8.2
Equity in earnings of affiliates	(4.6)
Other	(1.8)
Effective tax rate	<u>38.8%</u>

The tax effects of temporary differences that give rise to significant portions of the deferred tax assets at March 31, 2002 and 2001 were presented below:

	Millions of yen		Thousands of U.S.dollars
	2002	2001	2002
Deferred tax assets:			
Reserve for retirement benefits to employees	¥ 23,876	¥ 23,372	\$ 179,182
Inventories	2,516	2,122	18,882
Operating loss carried forward	4,429	1,581	33,238
Accrued expenses	1,391	1,824	10,439
Unrealized holding losses on securities	1,761	211	13,216
Other	1,494	1,083	11,212
Total gross deferred tax assets	<u>35,467</u>	<u>30,193</u>	<u>266,169</u>
Less valuation allowance	(73)	(256)	(548)
Deferred tax assets	<u>35,394</u>	<u>29,937</u>	<u>265,621</u>
Deferred tax liabilities:			
Depreciation	(4,141)	(3,306)	(31,077)
Unrealized holding gains on securities	(1,203)	(1,932)	(9,028)
Reserve for deferred income tax	(471)	(482)	(3,535)
Other	(235)	(253)	(1,763)
Deferred tax liabilities	<u>(6,050)</u>	<u>(5,973)</u>	<u>(45,403)</u>
Net deferred tax assets	<u>¥ 29,344</u>	<u>¥ 23,964</u>	<u>\$ 220,218</u>

13. Segment Information

(1) Geographic Segment Information

The segment information recognized by geographic origin for the years ended March 31, 2002 and 2001 was as follows:

Millions of yen							
2002							
	Japan	North America	Europe	Asia and other areas	Total	Elimination	Consolidated
Sales to customers	¥ 181,555	¥ 88,734	¥ 38,038	¥ 16,012	¥ 324,339	¥ —	¥ 324,339
Intersegment	57,247	291	50	6	57,594	(57,594)	—
Total sales	238,802	89,025	38,088	16,018	381,933	(57,594)	324,339
Operating expenses	234,214	87,622	37,704	14,930	374,470	(58,271)	316,199
Operating income	¥ 4,588	¥ 1,403	¥ 384	¥ 1,088	¥ 7,463	¥ 677	¥ 8,140
Assets	¥ 326,864	¥ 107,330	¥ 39,187	¥ 13,503	¥ 486,884	¥ (23,989)	¥ 462,895

Millions of yen							
2001							
	Japan	North America	Europe	Asia and other areas	Total	Elimination	Consolidated
Sales to customers	¥ 211,574	¥ 86,070	¥ 27,951	¥ 14,956	¥ 340,551	¥ —	¥ 340,551
Intersegment	57,092	337	39	1	57,469	(57,469)	—
Total sales	268,666	86,407	27,990	14,957	398,020	(57,469)	340,551
Operating expenses	258,782	83,164	27,799	13,870	383,615	(57,399)	326,216
Operating income	¥ 9,884	¥ 3,243	¥ 191	¥ 1,087	¥ 14,405	¥ (70)	¥ 14,335
Assets	¥ 351,054	¥ 104,271	¥ 32,813	¥ 13,096	¥ 501,234	¥ (22,289)	¥ 478,945

Thousands of U.S.dollars							
2002							
	Japan	North America	Europe	Asia and other areas	Total	Elimination	Consolidated
Sales to customers	\$ 1,362,514	\$ 665,921	\$ 285,464	\$ 120,165	\$ 2,434,064	\$ —	\$ 2,434,064
Intersegment	429,621	2,184	375	45	432,225	(432,225)	—
Total sales	1,792,135	668,105	285,839	120,210	2,866,289	(432,225)	2,434,064
Operating expenses	1,757,704	657,576	282,957	112,045	2,810,282	(437,306)	2,372,976
Operating income	\$ 34,431	\$ 10,529	\$ 2,882	\$ 8,165	\$ 56,007	\$ 5,081	\$ 61,088
Assets	\$ 2,453,013	\$ 805,479	\$ 294,086	\$ 101,336	\$ 3,653,914	\$ (180,030)	\$ 3,473,884

(2) Overseas sales

Net sales recognized by overseas sales destination, for the years ended March 31, 2002 and 2001 were as follows:

Millions of yen				
2002				
	North America	Europe	Asia and other areas	Total
Overseas sales	¥ 87,774	¥ 38,748	¥ 28,737	¥ 155,259
Consolidated net sales	—	—	—	¥ 324,339
Ratio of overseas sales to consolidated sales	27.1%	11.9%	8.9%	47.9%

Millions of yen				
2001				
	North America	Europe	Asia and other areas	Total
Overseas sales	¥ 85,925	¥ 30,449	¥ 29,043	¥ 145,417
Consolidated net sales	—	—	—	¥ 340,551
Ratio of overseas sales to consolidated sales	25.2%	8.9%	8.5%	42.7%

Thousands of U.S.dollars				
2002				
	North America	Europe	Asia and other areas	Total
Overseas sales	\$ 658,717	\$ 290,792	\$ 215,662	\$ 1,165,171
Consolidated net sales	—	—	—	\$ 2,434,064

Independent Auditor's Report



The Board of Directors and Shareholders
NTN CORPORATION

We have audited the consolidated balance sheets of NTN CORPORATION and consolidated subsidiaries as of March 31, 2002 and 2001, and the related consolidated statements of income, shareholders' equity and cash flows for the years then ended, all expressed in yen. Our audits were made in accordance with auditing standards, procedures and practices generally accepted and applied in Japan and, accordingly, included such tests of the accounting records and such other auditing procedures as we considered necessary in the circumstances.

In our opinion, the accompanying consolidated financial statements, expressed in yen, present fairly the financial position of NTN CORPORATION and consolidated subsidiaries as of March 31, 2002 and 2001, and the results of their operations and their cash flows for the years then ended in conformity with accounting principles and practices generally accepted in Japan applied on a consistent basis.

As described in Note 2 to the consolidated financial statements, NTN CORPORATION and consolidated subsidiaries have adopted new accounting standards for retirement benefit, financial instruments and translation of foreign currencies, effective April 1, 2000.

The U.S. dollar amounts in the accompanying consolidated financial statements with respect to the year ended March 31, 2002 are presented solely for convenience of the reader. Our audit also included the translation of yen amounts into U.S. dollar amounts and, in our opinion, such translation has been made on the basis described in note 1 to the consolidated financial statements.

Shin Nihon & Co.

Osaka, Japan
June 27, 2002

Shin Nihon & Co.

See note 1 to the consolidated financial statements which explains the basis of preparing the consolidated financial statements of NTN CORPORATION and consolidated subsidiaries under Japanese accounting principles and practices.

NTN Group Investment Holdings

As of March 31, 2002

Consolidated Subsidiaries	Paid-in-capital	Holding in percent
HIGASHINIHON NTN SERVICE CORP.	¥40,000,000	100
KYOEI NTN CORP.	¥20,000,000	100
NTN KONGO CORP.	¥1,000,000,000	100
NTN ENGINEERING PLASTICS CORP.	¥100,000,000	100
NTN POWDER METAL CORP.	¥400,000,000	40(60)
NTN MIKUMO COMPANY LTD.	¥450,000,000	100
NTN CASTING CORP.	¥450,000,000	100(3.3)
NTN KISHIWADA CORP.	¥20,000,000	100
NTN KINAN CORP.	¥450,000,000	100
NTN USA CORP.	US.\$97,820,000	100
NTN BEARING CORP. OF AMERICA	US.\$24,700,000	100(100)
NTN DRIVESHAFT, INC.	US.\$38,580,000	100(100)
AMERICAN NTN BEARING MFG. CORP.	US.\$24,330,000	100(100)
NTN-BOWER CORP.	US.\$67,000,000	100(100)
NTN-BCA CORP.	US.\$16,000,000	100(100)
NTN BEARING CORP. OF CANADA LTD.	CAN.\$20,100,000	100
NTN SUDAMERICANA, S.A.	US.\$700,000	100
NTN WÄLZLAGER (EUROPA) G.m.b.H.	EUPO 14,500,000	100
NTN KUGELLAGERFABRIK (DEUTSCHLAND) G.m.b.H.	EURO 18,500,000	100
NTN BEARINGS (UK) LTD.	STG. £ 2,600,000	100(0.04)
NTN FRANCE S.A.	EURO 3,700,000	99.999(0.006)
NTN TRANSMISSIONS EUROPE	EURO 38,100,000	80
NTN BEARING-SINGAPORE (PTE) LTD.	S.\$12,000,000	100(2.9)
NTN CHINA LTD.	HK.\$2,500,000	100
NTN BEARING-THAILAND CO., LTD.	BAHT 10,000,000	49(49)[51]
NTN MANUFACTURING (THAILAND) CO., LTD.	BAHT 347,000,000	99.999(0.001)
NTN BEARING-MALAYSIA SND. BHD.	M.\$350,000	60(60)
NTN KOREA CO., LTD.	WON 500,000,000	100

Affiliated Companies Accounted for by the Equity Method

SOCIÉTÉ NOUVELLE DE TRANSMISSIONS DU MANS	EURO 32,994,600	20
TUNG PEI INDUSTRIAL CO., LTD.	NT.\$1,257,232,620	27.35
TAIWAY LTD.	NT.\$160,000,000	36.25
UNIDRIVE PTY. LTD.	A.\$5,000,000	40

Notes: 1) NTN Corporation's share of voting rights in NTN Powder Metal Corp. and NTN Bearing-Thailand Co., Ltd. is less than 50%. As these companies are substantially controlled by NTN Corporation, however, they are treated as subsidiaries.

2) As for voting rights, the figure in parentheses indicates the percentage indirectly owned, and is included as part of the total holding. The figure in brackets indicates the percentage owned by parties having close ties with the Company. It is not included in the ownership percentage.

NTN's Global Network

As of September 1, 2002

Japan

Sales

AUTOMOTIVE SALES HEADQUARTERS

INDUSTRIAL SALES HEADQUARTERS

6th Floor, TOC Bldg., 22-17 Nishi-Gotanda

7-chome, Shinagawa-ku, Tokyo

141-0031, Japan

Phone : +81-3-5487-2826

Fax : +81-3-5487-2940

PRECISION EQUIPMENT DIVISION

6th Floor, TOC Bldg, 22-17 Nishi-Gotanda

7-chome, Shinagawa-ku, Tokyo

141-0031, Japan

Phone : +81-3-5487-2867

Fax : +81-3-5487-2713

FLUID DYNAMIC BEARING UNIT DIVISION

101 Katsutaba, Kanie-cho, Ama-gun,

Aichi Prefecture 497-8541, Japan

Phone : +81-5679-5-5005

Fax : +81-5679-5-5939

HIGASHINIHOH NTN SERVICE CORP.

3-1, 1-chome, Takanawa, Minato-ku,

Tokyo 108-0074, Japan

Phone : +81-3-3440-3321

Fax : +81-3-3440-3334

KYOEI NTN CORP.

26-4 Hikawa-cho, Itabashi-ku, Tokyo

173-0013, Japan

Phone : +81-3-3963-2755

Fax : +81-3-3963-2760

Manufacturing

Kuwana Works

2454 Aza-Tsuchijima, Oaza Higashikata,

Kuwana, Mie 511-8678, Japan

Phone : +81-594-24-1811

Fax : +81-594-21-0840

Iwata Works

1578 Higashi-Kaizuka, Iwata,

Shizuoka 438-8510, Japan

Phone : +81-538-37-8000

Fax : +81-538-37-8009

Okayama Works

500-1 Hatada, Bizen,

Okayama 705-8510, Japan

Phone : +81-869-66-6701

Fax : +81-869-66-8101

Takarazuka Works

2-1 Toyo-cho, Takarazuka, Hyogo

665-0032, Japan

Phone : +81-797-71-1131

Fax : +81-797-71-1818

Nagano Works

14017-11, Oaza-Nakaminowa,

Minowa-machi, Kamiina-gun, Nagano

399-4601, Japan

Phone : +81-265-79-8880

Fax : +81-265-79-8881

NTN KONGO CORP.

177 Kido-cho, Kawachinagano, Osaka

586-0001, Japan

Phone : +81-721-53-1317

Fax : +81-721-54-6981

NTN ENGINEERING PLASTICS CORP.

970 Oaza Ano, Toin-cho, Inabe-gun,

Mie 511-0243, Japan

Phone : +81-594-76-7221

Fax : +81-594-76-7244

NTN POWDER METAL CORP.

101 Katsutaba, Kanie-cho, Ama-gun,

Aichi Prefecture 497-8541, Japan

Phone : +81-5679-5-3913

Fax : +81-5679-5-6160

NTN MIKUMO COMPANY LTD.

750-1 Oaza-Onoe, Mikumo-cho,

Ichishi-gun, Mie Prefecture

515-2109, Japan

Phone : +81-59856-3311

Fax : +81-59856-4962

NTN KISHIWADA CORP.

83 Nishi-Oji-cho, Kishiwada,

Osaka 596-0802, Japan

Phone : +81-724-45-2993

Fax : +81-724-44-1544

NTN CASTING CORP.

475-1, Nadabun-cho, Hirata,

Shimane Prefecture 691-0003, Japan

Phone : +81-853-63-3108

Fax : +81-853-63-3463

NTN KINAN CORP.

2504-1 Ikuma, Kamitonda-cho,

Nishimuro-gun, Wakayama Prefecture

649-2103, Japan

Phone : +81-739-47-1801

Fax : +81-739-47-1829

HIKARI SEIKI INDUSTRY CO., LTD.

8 Motohigashikata, Sanmaiden-cho, Tenri,

Nara-Prefecture 632-0046, Japan

Phone : +81-743-66-0285

Fax : +81-743-67-1512

The Americas

Holding Company

NTN USA CORP.

1600 E. Bishop Court, P.O. Box 7604,

Mount Prospect, IL 60056-7604, U.S.A.

Phone : +1-847-298-7500

Fax : +1-847-294-1209

Sales

NTN BEARING CORP. OF AMERICA

1600 E. Bishop Court, P.O. Box 7604,

Mount Prospect, IL 60056-7604, U.S.A.

Phone : +1-847-298-7500

Fax : +1-847-699-9744

NTN BEARING CORP. OF CANADA LTD.

6595 Ordan Drive, Mississauga, Ontario,

L5T 1X2, Canada

Phone : +1-905-564-2700

Fax : +1-905-564-7749

NTN SUDAMERICANA, S.A.

World Trade Center Panamá

Calle 53 Este,

Urbanización Marbella Piso NO.16,

Oficina 1601

Apartado Postal 832-0487, Panamá,

Rep.de Panamá

Phone : +507-269-4777

Fax : +507-264-5592

NTN DE MEXICO, S.A.

Calle 22 No.2465, Esq, Calle 3,

Zona Industrial, C.P. 44940 Guadalajara,

Jalisco, Mexico

Phone : +52-3-145-1490

Fax : +52-3-145-1594

NTN DO BRASIL LTDA.

Av. Moema, 94-9 ºAndar, Conj. 92/93

Cep 04077-020, Indianópolis,

São Paulo, SP, Brasil

Phone : +55-11-5051-0600

Fax : +55-11-5051-2807

Manufacturing

AMERICAN NTN BEARING MFG. CORP.

Schiller Park Plant

9515 Winona Avenue, Schiller Park,
IL 60176, U.S.A.
Phone : +1-847-671-5450
Fax : +1-708-681-5298

Elgin Plant

1500 Holmes Road, Elgin, IL 60123, U.S.A.
Phone : +1-847-741-4545
Fax : +1-847-888-1226

NTN-BOWER CORP.

Macomb Plant

711 North Bower Road, Macomb,
IL 61455-2511, U.S.A.
Phone : +1-309-833-4541
Fax : +1-309-837-7373

Hamilton Plant

2086 Military Street South,
Hamilton, AL 35570, U.S.A.
Phone : +1-205-921-2173
Fax : +1-205-921-2059

NTN DRIVESHAFT, INC.

8251 South International Drive
Columbus, IN 47201, U.S.A.
Phone : +1-812-342-7000
Fax : +1-812-342-1155

NTN-BCA CORP.

Lititz Plant

401 West Lincoln Avenue, Lititz,
PA 17543-7020, U.S.A.
Phone : +1-717-627-3623
Fax : +1-717-627-4560

Greensburg Plant

987 North U.S. Highway 421, Greensburg,
IN 47240-9399, U.S.A.
Phone : +1-812-663-3361
Fax : +1-812-663-5442

NTN BEARING MFG. CANADA A DIV. OF NTN BEARING CORP. OF CANADA LTD.

6740 Kitimat Road, Mississauga, Ontario,
L5N 1M6, Canada
Phone : +1-905-826-5500
Fax : +1-905-821-3486

Europe

Sales

NTN WÄLZLAGER (EUROPA) G.m.b.H.

Max-Planck-Strasse 23, 40699 Erkrath,
F.R. Germany
Phone : +49-211-2508-0
Fax : +49-211-2508400

NTN BEARINGS (UK) LTD.

Wellington Crescent, Fradley Park,
Lichfield, Staffordshire, WS13 8RZ, U.K.
Phone : +44-1543-445000
Fax : +44-1543-445035

NTN FRANCE S.A.

Z.I. Sabliere BP 338
Schweighouse Sur Moder 67507
Haguenau Cedex, France
Phone : +33-3-88-53-2222
Fax : +33-3-88-73-4695

Manufacturing

NTN KUGELLAGERFABRIK (DEUTSCHLAND) G.m.b.H.

NTN Strasse 1-3 40822 Mettmann,
F.R. Germany
Phone : +49-2104-1409-0
Fax : +49-2104-13138

NTN TRANSMISSIONS EUROPE

Z.A. des Trémelières Communauté
Urbaine du Mans
72704 Allonnes Cedex, France
Phone : +33-2-43-83-9000
Fax : +33-2-43-83-9030

SOCIÉTÉ NOUVELLE DE TRANSMISSIONS DU MANS

15, avenue Pierre Piffault
72027 Le Mans Cedex 2, France
Phone : +33-2-43-16-40-50
Fax : +33-2-43-16-42-05

Asia and Other Areas

Sales

NTN BEARING-SINGAPORE (PTE) LTD.

No.9 Clementi Loop Singapore 129812
Phone : +65-64698066
Fax : +65-64695400

NTN CHINA LTD.

Rm. 1914-1915, Park-in Commercial Centre,
56 Dundas Street, Kowloon, Hong Kong
Phone : +852-2385-5097
Fax : +852-2385-2138

NTN BEARING-THAILAND CO., LTD

12th Floor, Panjathani Tower,
127/15 Nonsee Road, Chongnonsee Yannawa,
Bangkok 10120, Thailand
Phone : +66-2-681-0401
Fax : +66-2-681-0408

NTN BEARING-MALAYSIA SDN. BHD.

Lot No. 764C, 4 1/2 Miles Jalan Kelang Lama,
58000 Kuala Lumpur, Malaysia
Phone : +60-3-79817931
Fax : +60-3-79814678

NTN KOREA CO., LTD.

2nd Floor, KCCI Bldg.45,
Namdæmun-ro 4-ga, Chung-ku, Seoul,
100-743, Korea
Phone : +82-2-757-9005
Fax : +82-2-779-4150

NTN-CBC (AUSTRALIA) PTY. LTD.

3, The Crescent,
Kingsgrove, NSW 2208,
LOCKED BAG 1800, Kingsgrove 1480
Australia
Phone : +61-2-9502-1833
Fax : +62-2-9502-4013

Manufacturing

NTN MANUFACTURING (THAILAND) CO., LTD.

111/2 Moo 4, Tambol Pluakdaeng,
Amphur Pluakdaeng,
Rayong 21140, Thailand
Phone : +66-38-955-185
Fax : +66-38-955-191

TUNG PEI INDUSTRIAL CO., LTD.

10th Floor No.142, Chung Hsiao E.Rd.,
Sec. 4, Taipei, Taiwan, R.O.C.
Phone : +886-2-2741-7321
Fax : +886-2-2741-6623

TAIWAY LTD.

No.14, Kwang Fu Road, Hukou Hsiang,
Hsin Chu Hsien, Taiwan, R.O.C.
Phone : +886-3-5983601
Fax : +886-3-5982787

UNIDRIVE PTY. LTD.

45-49 McNaughton Road,
Clayton, Victoria 3168
Australia
Phone : +61-3-9542-4100
Fax : +61-3-9544-8117

Management

As of July 15, 2002

Yasunobu Suzuki



Masashi Sanami



Shichiro Fukumoto



Yasuhiro Gotoh



Tomosaburo Ogiuchi



Naokazu Iyama



DIRECTORS

Yasunobu Suzuki*
President

Masashi Sanami*
Deputy President

Shichiro Fukumoto
Senior Managing Director

Yasuhiro Gotoh*
Senior Managing Director

Tomosaburo Ogiuchi
Senior Managing Director

Naokazu Iyama
Senior Managing Director

Hiroshi Katsuma
Managing Director

Takehiko Murakami
Managing Director

Hiroyuki Tomari
Managing Director

Satoshi Miyatake
Director

Morihisa Itoh
Director

Naohiko Fujimura
Director

Hideo Sofue
Director

Junji Oba
Director

Osamu Wakisaka
Director

Wasaburo Suganuma
Director

Tadatoshi Kato
Director

Katsuhiro Inoue
Director

Katsuhiko Machiyama
Director

* Representative Directors

AUDITORS

Hideki Takeda
Standing Statutory Auditor

Mitsunobu Matsuo
Standing Statutory Auditor

Tadataka Nishiyama
Statutory Auditor

Isamu Nakano
Statutory Auditor

Investor Information

Head Office

NTN Corporation
 3-17 Kyomachi-bori 1-chome, Nishi-ku,
 Osaka 550-0003 Japan
 Investor Relations
 Phone: +81-6-6449-3612
 Fax: +81-6-6443-6966
 E-mail: sysad@osa.ntn.co.jp

NTN on the Internet

NTN's Website offers a variety of corporate and product information, including the latest annual report and financial results.
<http://www.ntn.co.jp>

Common Stock

Authorized 800,000,000 shares
 Issued and outstanding 463,056,775 shares

Number of Shareholders (As of March 31, 2002)
 36,631

Transfer Agent for Common Stock

UFJ Trust Bank Limited
 4-3, 1-chome, Marunouchi, Chiyoda-ku, Tokyo,
 100-0005, Japan

Stock Exchange Listings

Tokyo, Osaka, Nagoya, Fukuoka, and Sapporo stock exchanges (#6472)

Independent Accountants

Shin Nihon & Co.

General Meeting of Shareholders

The General Meeting of Shareholders was held on June 27, 2002 in Osaka

Stock Price Range in Fiscal 2001

High: ¥370 (May 2, 2001, May 7, 2001)
 Low: ¥193 (December 20, 2001)

Shareholders by category

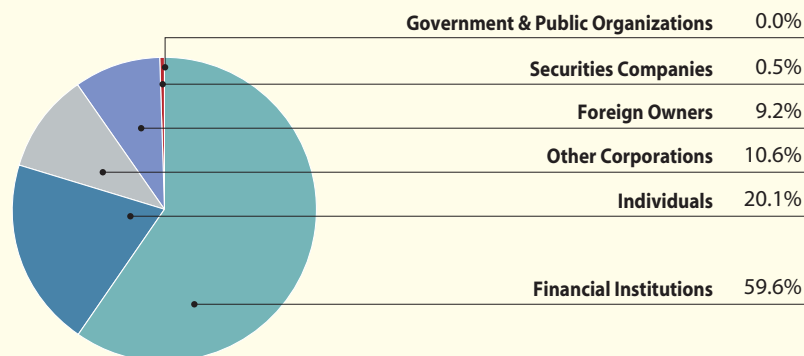

Tokyo Stock Price Range

Monthly stock price (yen)

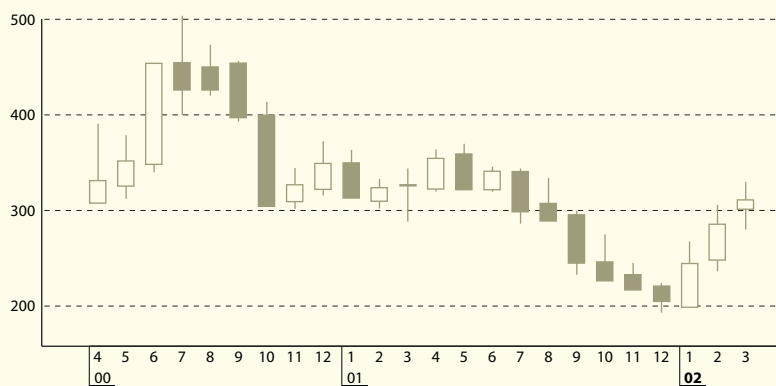

Monthly volume traded (Million shares)

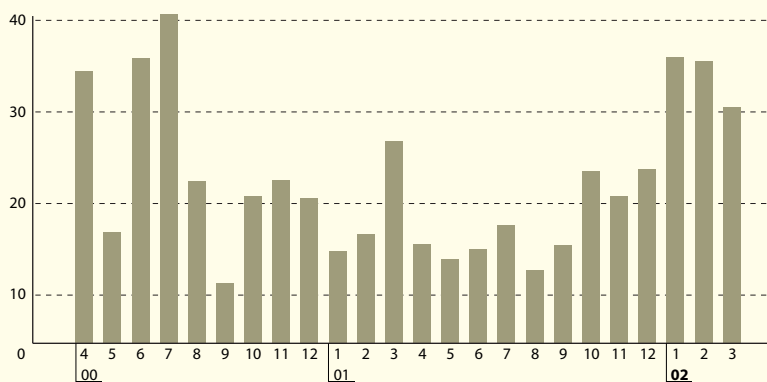

For New Technology Network



NTN Corporation

Head Office

3-17, 1-chome, Kyomachibori, Nishi-ku,
Osaka 550-0003, Japan

<http://www.ntn.co.jp>