

For New Technology Network

**NTN**®

NTN corporation

# Bearing Units Plastic Housing Series

CAT. No. 3904-III / E

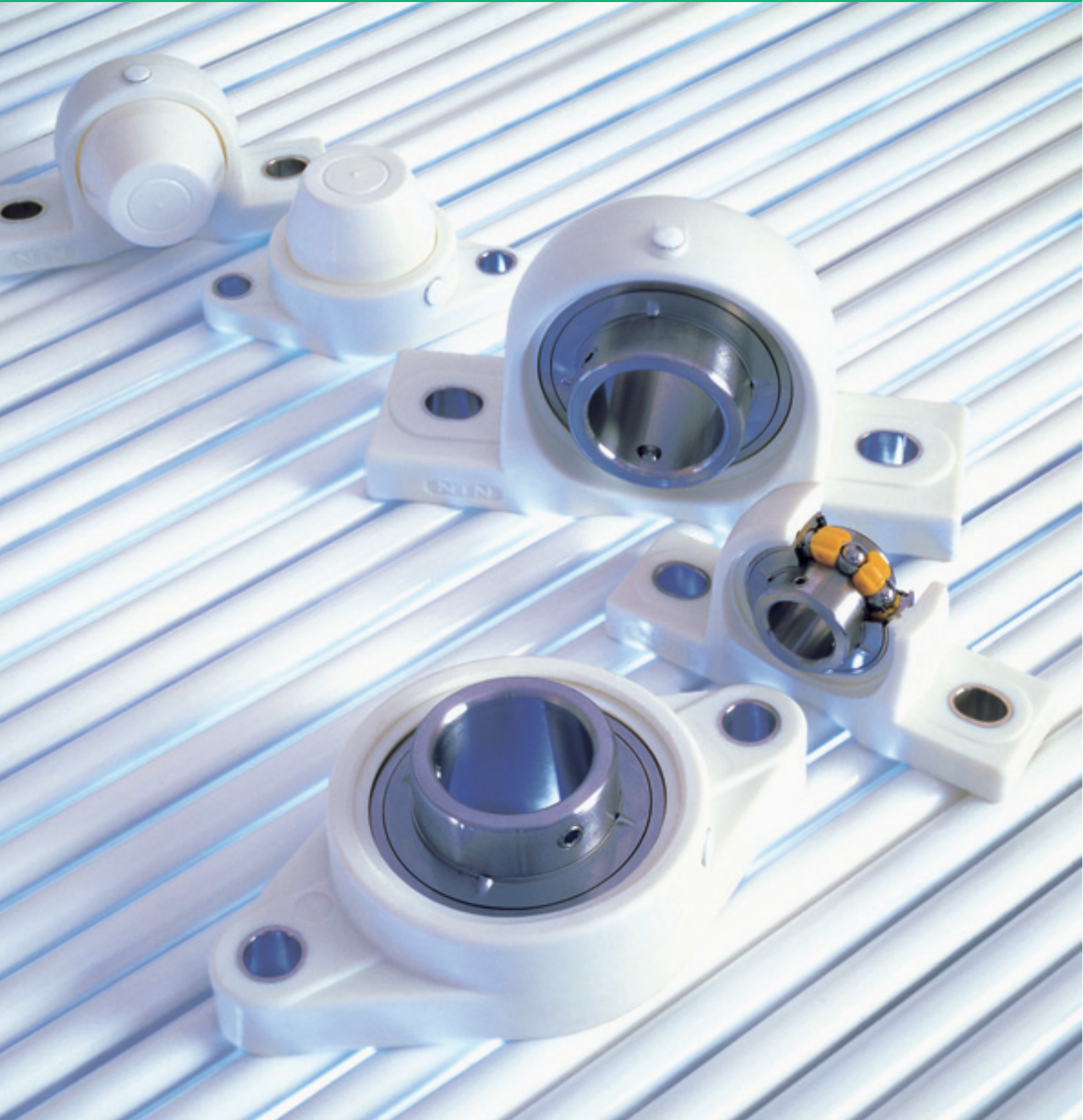

# The NTN plastic series ensures a clean operating environment.

## 1. Features

### Guards against corrosion

NTN bearing units in the plastic series feature ball bearings inserted into housings made of plastics that provide superior resistance to corrosion as compared to standard series cast iron units. This series is especially useful in a wide variety of applications because of the nonmagnetic and rust free properties of the housing.

### Maintains a clean operating environment

The solid grease lubricant in the ball bearing, solely developed by NTN, reduces leakage from the bearing, significantly reducing environmental pollution. Also, the housing will not stain, nor is there paint to peel and contaminate the environment.

### Low torque characteristics

The standard solid grease type for these ball bearing units is spot-pack which places the lubricant on the bearing cage. Torque consumption capabilities of spot-pack bearings is low due to reduced whip resistance in comparison to standard grease lubricated ball bearings.

### Light weight

Weight is reduced more than 30% to 60% over standard series units.

### Water resistant

The glass filled polyester housing not only reduces corrosion but offers better water resistance.

## 2. Materials

Parts		Materials
Bearing	Raceways	Martensite stainless steel (equivalent to SUS440C)
	Rolling element	Martensite stainless steel (SUS440C)
	Slinger, Cage	Austenite stainless steel (SUS304)
	Rubber seal	Nitril rubber
	Set screw(W shape screw head)	Martensite stainless steel (SUS410)
Bearing housing	Housing	Glass reinforced Polyester (VALOX 420)**
	Sleeve for set bolt	Austenite stainless steel (SUS 304)
	Nut for grease nipple	Austenite stainless steel (SUS 304)
Dust cover		Polypropylene
Plug		Polyethylene

\*\*VALOX is a trade mark of General Electric Company

## 3. Recommended operating temperature and allowable speed

Bearings with solid grease are recommended to operate under -20 to +80°C. However, operating temperature should be below +60°C when bearing is operated with continuous use.

$dn$  value:  $12 \times 10^4$   
( $dn$ = bore diameter in mm  $\times$  speed in  $\text{min}^{-1}$ )

**Remarks:** The recommended operating temperature range and allowable speed is applied to all bearings with solid grease. Contact NTN when your application exceeds these recommendations. For standard grease, the maximum recommended temperature for plastic units is 80°C to prevent creeping between bearing outer ring and housing bore.

## 4. Compatibility and Handling

Basically, the plastic housing series is compatible with standard cast iron series units when setting, however, the nominal setting bolt diameter may differ from the standard series. The housing should be handled carefully and may be damaged if dropped on hard surfaces or hit with metal hammers. An electrostatic charge may be generated in certain operating conditions, making it inadvisable for use when flammable or explosive conditions may occur. The unit may be regreased using the plug on the housing, however relubrication is not recommended when unit ball bearings are packed with solid grease.

## 5. Applications

Bearings with solid grease are suitable for applications requiring a clean operating environment such as: food processing and packaging machinery, chemical processing machines, etc.

## 6. Option

When a stainless steel insert bearing is not required, a standard steel insert bearing can be applied. In that case a relubricable type will be provided. Contact NTN for additional information.

## Recommended tightening torque for set screw

Unit: N·m/lbf·inch

Bearing number (F-UC)	Designation of set screws (W shape screw head)		Tightening torques (Max)	
	Metric series	Inch series	N·m	lbf·inch
204, 205	M5×0.8	No.10-32UNF	3.9	34
206	M6×0.75	1/4-28UNF	4.9	43
207	M6×0.75	1/4-28UNF	5.8	52
208	M8×1	5/16-24UNF	7.8	69

Tighten the two set screws uniformly using the torque listed in this table. Over tightening the set screw may cause the inner ring to crack.

## Recommended tightening torque for setting bolt

Unit: N·m/lbf·inch

Housing number	Nominal bolt dia.		Tightening torques (Max.)	
	Metric series	Inch series	N·m	lbf·inch
PR204D1	M10	3/8	17.7	156
PR205D1			24.5	217
PR206D1	M12	7/16	29.4	260
PR207D1			35.3	312
PR208D1			45.1	399
FLR204D1	M10	3/8	17.7	156
FLR205D1			24.5	217
FLR206D1			29.4	260
FLR207D1	M12	7/16	35.3	312
FLR208D1			40.2	356





Over tightening the setting bolt may deform the plastic housing. Use the tightening torque guideline listed in this table.

NTN recommends the use of a washer between the bolt and housing base. If a washer is not used, damage to the base could occur.

## Plastic housing static strength

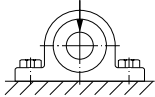
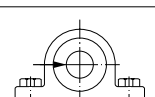
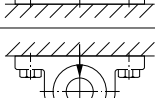
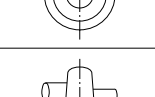
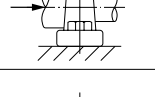
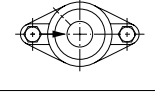
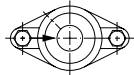
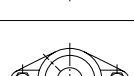
The table below indicates the static strength of plastic housings at room temperature (23.5°C). The static strength of plastic housings varies by operating temperature, housing type and load direction and must be factored into the selection process. NTN recommends using safety equipment should the housing become damaged or broken, creating a dangerous working environment.

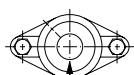
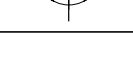
Unit: N/lbf

Type of housing	Direction of load	Static strength of housing					
		Nominal number					
		204	205	206	207	208	
PR	Downward		16,600	19,600	2,830	38,300	44,500
			3,730	4,410	6,370	8,620	10,000
	Horizontal		7,000	7,400	8,600	10,300	12,100
			1,570	1,680	1,940	2,310	2,710
	Upward		5,600	5,800	6,000	6,600	11,100
		※Not recommended.	1,260	1,300	1,340	1,480	2,490
	Axial direction		3,000	3,200	4,000	5,700	8,500
		※Not recommended.	680	730	900	1,280	1,920
FLR	Horizontal		5,600	8,000	10,800	13,800	17,300
			1,260	1,810	2,430	3,110	3,880
	45 degrees upward		6,600	8,400	10,300	12,200	14,000
			1,480	1,900	2,310	2,730	3,150
	Upward		7,400	7,600	8,500	10,700	15,100
			1,680	1,720	1,920	2,400	3,400

## ■ Dimensions for dust cover

Unit: mm/ inch

Cover number	Dimensions					
	D <sub>1</sub>		D <sub>2</sub>		L	
RM-204	36	1 $\frac{13}{32}$	50	1 $\frac{31}{32}$	29.5	1 $\frac{5}{32}$
RM-205	41	1 $\frac{5}{8}$	55	2 $\frac{5}{32}$	31.0	1 $\frac{7}{32}$
RM-206	50	1 $\frac{31}{32}$	64	2 $\frac{17}{32}$	35.0	1 $\frac{3}{8}$
RM-207	60	2 $\frac{3}{8}$	74	2 $\frac{15}{16}$	38.0	1 $\frac{1}{2}$
RM-208	68	2 $\frac{11}{16}$	84	3 $\frac{5}{16}$	40.0	1 $\frac{9}{16}$

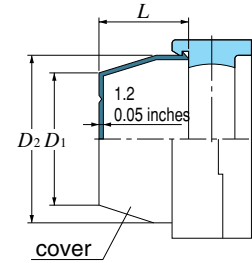

## ■ Water and chemical resistance of housing (VALOX 420®)

Among engineering plastics, VALOX has better water absorption characteristics (0.06% at 23°C over 24 hours) and better dimensional stability. VALOX is made of crystallized polymer and while not affected by organic solvents, is affected by alkaline, making it important to consider the operating environment. The table demonstrates VALOX's chemical resistance when soaked in solvent at 30 or 90 days.

	Chemicals	Temperature °C	Deterioration ratio <sup>1)</sup> %			Chemicals	Temperature °C	Deterioration ratio <sup>1)</sup> %		
			Number of days soaked					Number of days soaked		
			30 days	90 days				30 days	90 days	
Acid	Hydrochloric acid, 10%	23	89	85	Organic solvent	Ethyl alcohol	23	99	96	
	Sulfuric acid, 36%	23	97	97		Methyl alcohol	23	91	82	
		60	84	60		Isopropyl alcohol	23	100	100	
	Acetic acid 10%	23	88	88		Acetone	23	86	74	
Alkaline	Potassium hydroacid, 5%	23	88	10		Methyl Ethyl Keton	23	90	80	
	Sodium hydroacid, 10%	23	※	※		Ethyl acetate	23	96	86	
	Ammonia hydroacid, 10%	23	96	87		Methylene chloride	23	54	54	
Oil	Motor oil	23	100	100		ethylene glycole	23	100	100	
	Brake oil	23	100	100		Sodium	Zinc chrolide 10%	23	97	94
	Gasoline (Regular)	23	100	100			Calcium chrolide 10%	23	98	98
		60	93	90	Sodium chrolide 5%		23	97	97	

**Remarks 1)** Deterioration (%) is the strength after test divided by the strength before test.

The ※ symbol indicates that results could not be measured as the test piece dissolved.

**Remarks 2)** The values listed in the table are not guaranteed as they are the result of soaking without operating stresses on the sample. Because this strength data is general, it does not apply under all operating conditions. Actual housing strength will vary depending on the type and concentration of liquid, temperature, load, etc.

**Remarks 3)** Technical data provided by General Electric Company.

## ■ Anti-Corrosion capability

NTN recommends ratings of ◎ to ○ for optimum corrosion resistance. ◎ ← → poor

Materials	Condition	Atmosphere		Water		Acid		
		Dry	Wet	Natural water	Sodium water	Nitric acid	Sulfuric acid	Hydrochloric acid
Martensite stainless steel	SUS440C, SUS410	○	△	△	▲	▲	×	×
Austenite stainless steel	SUS304, SCS13	◎	◎	◎	○	◎	○	△
Polyester plastics	VALOX 420	◎	◎	◎	◎	▲	○	○
Polypropylene, polyethylene		◎	◎	◎	◎	○	○	○
High carbon steel	SUJ2	△	▲	▲	×	×	×	×
Carbon steel, Cast iron		▲	×	×	×	×	×	×

**Remarks:** This data is obtained by observation of the surface conditions of materials.

Note that these anti-corrosion capabilities are altered by anti-corrosion surface treatment.

Not recommended for use in liquid.

# Pillow type bearing unit F-UCPR2 series

Cylindrical bore, set screw type

Shaft dia. mm inch	Unit number	Nominal dimensions											Bolt size	Bearing number	Housing number	Mass of unit (Ref.) kg lb
		H	L	J	A	N	N <sub>1</sub>	H <sub>1</sub>	H <sub>2</sub>	B	S					
20 3/4	F-UCPR204/LP03	33.3	127	95	38	11	14	14.2	65	31	12.7	M10	F-UC204D1/LP03	PR204D1	0.3	
	F-UCPR204-012/LP03	1 5/16	5	3 3/4	1 1/2	7/16	9/16	2 9/16	1.2205	0.500	3/8	F-UC204-012D1/LP03	PR204D1	0.7		
25 13/16 7/8 15/16 1	F-UCPR205/LP03	36.5	140	105	38	11	14	14.5	71	34.1	14.3	M10	F-UC205D1/LP03	PR205D1	0.3	
	F-UCPR205-013/LP03												F-UC205-013D1/LP03			
	F-UCPR205-014/LP03	1 7/16	5 1/2	4 1/8	1 1/2	7/16	9/16	2 25/32	1.3425	0.563	3/8	F-UC205-014D1/LP03	PR205D1	0.7		
	F-UCPR205-015/LP03												F-UC205-015D1/LP03			
	F-UCPR205-100/LP03												F-UC205-100D1/LP03			
30 1 1/16 1 1/8 1 3/16 1 1/4	F-UCPR206/LP03	42.9	162	119	46	14	18	17.8	83	38.1	15.9	M12	F-UC206-D1/LP03	PR206D1	0.5	
	F-UCPR206-101/LP03												F-UC206-101D1/LP03			
	F-UCPR206-102/LP03	1 11/16	6 3/8	4 11/16	1 13/16	9/16	23/32	1 1/16	3 9/32	1.5000	0.626	7/16	F-UC206-102D1/LP03	PR206D1	1.1	
	F-UCPR206-103/LP03												F-UC206-103D1/LP03			
	F-UCPR206-104/LP03												F-UC206-104D1/LP03			
35 1 1/4 1 5/16 1 3/8 1 1/2	F-UCPR207/LP03	47.6	167	127	48	14	18	18	94	42.9	17.5	M12	F-UC207D1/LP03	PR207D1	0.7	
	F-UCPR207-104/LP03												F-UC207-104D1/LP03			
	F-UCPR207-105/LP03	1 7/8	6 9/16	5	1 7/8	9/16	23/32	23/32	3 11/16	1.6890	0.689	7/16	F-UC207-105D1/LP03	PR207D1	1.5	
	F-UCPR207-106/LP03												F-UC207-106D1/LP03			
	F-UCPR207-107/LP03												F-UC207-107D1/LP03			
40 1 1/2 1 5/16	F-UCPR208/LP03	49.2	184	137	54	14	18	19.5	98	49.2	19	M12	F-UC208D1/LP03	PR208D1	1.0	
	F-UCPR208-108/LP03	1 15/16	7 1/4	5 13/32	2 1/8	9/16	23/32	25/32	3 27/32	1.9370	0.748	7/16	F-UC208-108D1/LP03	PR208D1	2.2	
	F-UCPR208-109/LP03												F-UC208-109D1/LP03			

Stainless bearing with solid grease + glass fiber reinforced plastic housing.

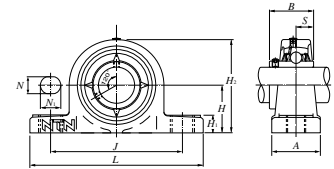

# Rhombus flange type bearing unit F-UCFLR2 series

Cylindrical bore, set screw type

Shaft dia. mm inch	Unit number	Nominal dimensions											Bolt size	Bearing number	Housing number	Mass of unit (Ref.) kg lb
		H	J	A <sub>2</sub>	A <sub>1</sub>	A	N	L	A <sub>0</sub>	B	S					
20 3/4	F-UCFLR204/LP03	113	90	15.4	11.4	26.5	11	64	33.7	31	12.7	M10	F-UC204D1/LP03	FLR204D1	0.3	
	F-UCFLR204-012/LP03	4 7/16	3 35/64	19/32	7/16	1 1/32	7/16	2 17/32	1 21/64	1.2205	0.500	3/8	F-UC204-012D1/LP03	FLR204D1	0.7	
25 13/16 7/8 15/16 1	F-UCFLR205/LP03	130	99	17	13.5	29.1	11	68	36.8	34.1	14.3	M10	F-UC205D1/LP03	FLR205D1	0.3	
	F-UCFLR205-013/LP03												F-UC205-013D1/LP03			
	F-UCFLR205-014/LP03	5 1/8	3 57/64	21/32	1 7/32	1 5/32	7/16	2 11/16	1 29/64	1.3425	0.563	3/8	F-UC205-014D1/LP03	FLR205D1	0.7	
	F-UCFLR205-015/LP03												F-UC205-015D1/LP03			
	F-UCFLR205-100/LP03												F-UC205-100D1/LP03			
30 1 1/16 1 1/8 1 3/16 1 1/4	F-UCFLR206/LP03	148	117	19	13.3	30.5	11	80	41.2	38.1	15.9	M10	F-UC206-D1/LP03	FLR206D1	0.5	
	F-UCFLR206-101/LP03												F-UC206-101D1/LP03			
	F-UCFLR206-102/LP03	5 13/16	4 39/64	3/4	1 7/32	1 3/16	7/16	3 5/32	1 5/8	1.5000	0.626	3/8	F-UC206-102D1/LP03	FLR206D1	1.1	
	F-UCFLR206-103/LP03												F-UC206-103D1/LP03			
	F-UCFLR206-104/LP03												F-UC206-104D1/LP03			
35 1 1/4 1 5/16 1 3/8 1 1/2	F-UCFLRM207/LP03	163	130	18	16.1	32.8	13	90	43.4	42.9	17.5	M12	F-UC207D1/LP03	FLR207D1	0.7	
	F-UCFLR207-104/LP03												F-UC207-104D1/LP03			
	F-UCFLR207-105/LP03	6 13/32	5 1/8	23/32	5/8	1 9/32	1/2	3 17/32	1 45/64	1.6890	0.689	7/16	F-UC207-105D1/LP03	FLR207D1	1.5	
	F-UCFLR207-106/LP03												F-UC207-106D1/LP03			
	F-UCFLR207-107/LP03												F-UC207-107D1/LP03			
40 1 1/2 1 5/16	F-UCFLR208/LP03	175	144	21.5	20	37.5	14	100	51.7	49.2	19	M12	F-UC208D1/LP03	FLR208D1	0.9	
	F-UCFLR208-108/LP03	6 7/8	5 43/64	27/32	25/32	1 15/32	9/16	3 15/16	2 1/32	1.9370	0.748	7/16	F-UC208-108D1/LP03	FLR208D1	2.0	
	F-UCFLR208-109/LP03												F-UC208-109D1/LP03			

Stainless bearing with solid grease + glass fiber reinforced plastic housing

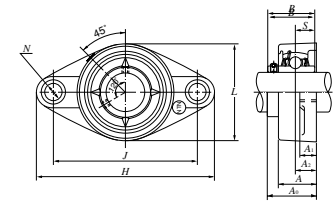

## Housing tolerances

### 1. Center height tolerances for pillow type bearing unit.

Unit: mm/inch

Housing part number	H deviation	DH <sub>s</sub>
PR204D1	±0.25 ±0.010	
PR205D1		
PR206D1		
PR207D1		
PR208D1		

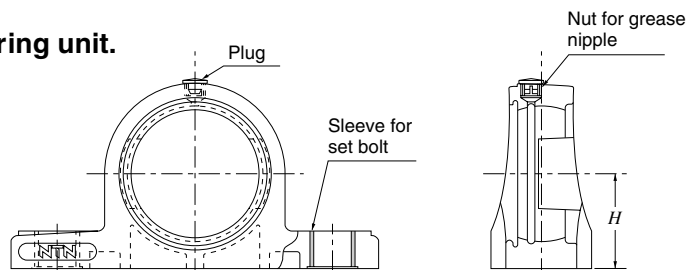

# Pillow type bearing unit F-RM-UCPR2 series

Cylindrical bore, set screw type

Shaft dia. mm inch	Unit number	Nominal dimensions mm inch											Bolt size	Bearing number	Housing number	Mass of unit (Ref.) kg lb
		H	L	J	A	N	N <sub>1</sub>	H <sub>1</sub>	H <sub>2</sub>	A <sub>1</sub>	B	S				
20 3/4	F-RM-UCPR204/LP03	33.3	127	95	38	11	14	14.2	65	39	31	12.7	M10	F-UC204D1/LP03	PR204D1	0.3
	F-RM-UCPR204-012/LP03	1 5/16	5	3 3/4	1 1/2	7/16	9/16	9/16	2 3/16	1 17/32	1.2205	0.500	3/8	F-UC204-012D1/LP03	PR204D1	0.7
25 1 3/16 7/8 15/16 1	F-RM-UCPR205/LP03	36.5	140	105	38	11	14	14.5	71	40	34.1	14.3	M10	F-UC205D1/LP03	PR205D1	0.3
	F-RM-UCPR205-013/LP03													F-UC205-013D1/LP03		
	F-RM-UCPR205-014/LP03													F-UC205-014D1/LP03		
	F-RM-UCPR205-015/LP03													F-UC205-015D1/LP03		
	F-RM-UCPR205-100/LP03	1 7/16	5 1/2	4 1/8	1 1/2	7/16	9/16	9/16	2 25/32	1 9/16	1.3425	0.563	3/8	F-UC205-100D1/LP03	PR205D1	0.7
30 1 1/16 1 1/8 1 3/16 1 1/4	F-RM-UCPR206/LP03	42.9	162	119	46	14	18	17.8	83	46	38.1	15.9	M12	F-UC206D1/LP03	PR206D1	0.5
	F-RM-UCPR206-101/LP03													F-UC206-101D1/LP03		
	F-RM-UCPR206-102/LP03													F-UC206-102D1/LP03		
	F-RM-UCPR206-103/LP03													F-UC206-103D1/LP03		
	F-RM-UCPR206-104/LP03	1 11/16	6 3/8	4 11/16	1 13/16	9/16	23/32	1 1/16	3 3/32	1 13/16	1.5000	0.626	7/16	F-UC206-104D1/LP03	PR206D1	1.1
35 1 1/4 1 5/16 1 3/8 1 1/2	F-RM-UCPR207/LP03	47.6	167	127	48	14	18	18	94	49	42.9	17.5	M12	F-UC207D1/LP03	PR207D1	0.7
	F-RM-UCPR207-104/LP03													F-UC207-104D1/LP03		
	F-RM-UCPR207-105/LP03													F-UC207-105D1/LP03		
	F-RM-UCPR207-106/LP03													F-UC207-106D1/LP03		
	F-RM-UCPR207-107/LP03	1 7/8	6 9/16	5	1 7/8	9/16	23/32	23/32	3 11/16	1 15/16	1.6890	0.689	7/16	F-UC207-107D1/LP03	PR207D1	1.5
40 1 1/2 1 5/16	F-RM-UCPR208/LP03	49.2	184	137	54	14	18	19.5	98	52	49.2	19	M12	F-UC208D1/LP03	PR208D1	1.0
	F-RM-UCPR208-108/LP03													F-UC208-108D1/LP03		
	F-RM-UCPR208-109/LP03	1 5/16	7 1/4	5 13/32	2 1/8	9/16	23/32	25/32	3 27/32	2 1/16	1.9370	0.748	7/16	F-UC208-109D1/LP03	PR208D1	2.2

Stainless bearing with solid grease + glass fiber reinforced plastic housing

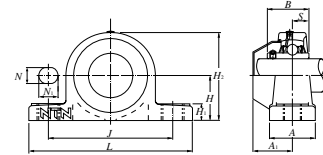

# Rhombus Flange type bearing unit F-RM-UCFLR2 series

Cylindrical bore, set screw type

Shaft dia. mm inch	Unit number	Nominal dimensions mm inch											Bolt size	Bearing number	Housing number	Mass of unit (Ref.) kg lb
		H	J	A <sub>2</sub>	A <sub>1</sub>	A	N	L	A <sub>0</sub>	A <sub>4</sub>	B	S				
20 3/4	F-RM-UCFLR204/LP03	113	90	15.4	11.4	26.5	11	64	33.7	53	31	12.7	M10	F-UC204D1/LP03	FLR204D1	0.3
	F-RM-UCFLR204-012/LP03	4 1/16	3 39/64	19/32	7/16	1 1/32	7/16	2 17/32	1 21/64	2 1/8	1.2205	0.500	3/8	F-UC204-012D1/LP03	FLR204D1	0.7
25 1 3/16 7/8 15/16 1	F-RM-UCFLR205/LP03	130	99	17	13.5	29.1	11	68	36.8	57	34.1	14.3	M10	F-UC205D1/LP03	FLR205D1	0.3
	F-RM-UCFLR205-013/LP03													F-UC205-013D1/LP03		
	F-RM-UCFLR205-014/LP03													F-UC205-014D1/LP03		
	F-RM-UCFLR205-015/LP03													F-UC205-015D1/LP03		
	F-RM-UCFLR205-100/LP03	5 1/8	3 57/64	21/32	17/32	1 5/32	7/16	2 11/16	1 29/64	2 1/4	1.3425	0.563	3/8	F-UC205-100D1/LP03	FLR205D1	0.7
30 1 1/16 1 1/8 1 3/16 1 1/4	F-RM-UCFLR206/LP03	148	117	19	13.3	30.5	11	80	41.2	64	38.1	15.9	M10	F-UC206D1/LP03	FLR206D1	0.5
	F-RM-UCFLR206-101/LP03													F-UC206-101D1/LP03		
	F-RM-UCFLR206-102/LP03													F-UC206-102D1/LP03		
	F-RM-UCFLR206-103/LP03													F-UC206-103D1/LP03		
	F-RM-UCFLR206-104/LP03	5 13/16	4 39/64	3/4	17/32	1 3/16	7/16	3 5/32	1 5/8	2 17/32	1.5000	0.626	3/8	F-UC206-104D1/LP03	FLR206D1	1.1
35 1 1/4 1 5/16 1 3/8 1 1/2	F-RM-UCFLR207/LP03	163	130	18	16.1	32.8	13	90	43.4	67	42.9	17.5	M12	F-UC207D1/LP03	FLR207D1	0.7
	F-RM-UCFLR207-104/LP03													F-UC207-104D1/LP03		
	F-RM-UCFLR207-105/LP03													F-UC207-105D1/LP03		
	F-RM-UCFLR207-106/LP03													F-UC207-106D1/LP03		
	F-RM-UCFLR207-107/LP03	6 13/32	5 1/8	23/32	5/8	1 9/32	1/2	3 17/32	1 45/64	2 5/8	1.6890	0.689	7/16	F-UC207-107D1/LP03	FLR207D1	1.5
40 1 1/2 1 5/16	F-RM-UCFLR208/LP03	175	144	21.5	20	37.5	14	100	51.7	74	49.2	19	M12	F-UC208D1/LP03	FLR208D1	0.9
	F-RM-UCFLR208-108/LP03													F-UC208-108D1/LP03		
	F-RM-UCFLR208-109/LP03	6 7/8	5 43/64	27/32	25/32	1 15/32	9/16	3 15/16	2 3/32	2 15/16	1.9370	0.748	7/16	F-UC208-109D1/LP03	FLR208D1	2.0

Stainless bearing with solid grease + glass fiber reinforced plastic housing

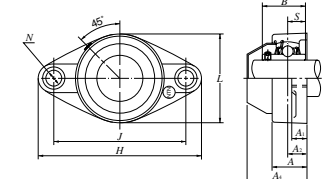

## Housing tolerances

2. Tolerances for rhombus flange type housing. Unit: mm/inch

Housing number	A <sub>2</sub> deviation ΔA <sub>2</sub>	Tolerances for mounting bolt holes
FLR204D1	±0.7 ±0.028	±0.5 ±0.020
FLR205D1		
FLR206D1		
FLR207D1		
FLR208D1		

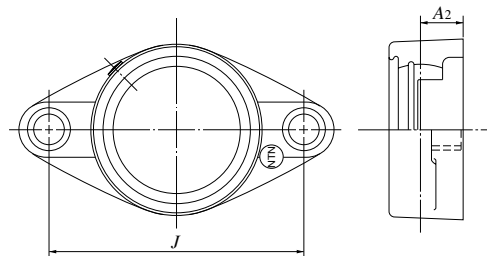

# Stainless insert bearing

## Cylindrical bore, set screw type with solid grease

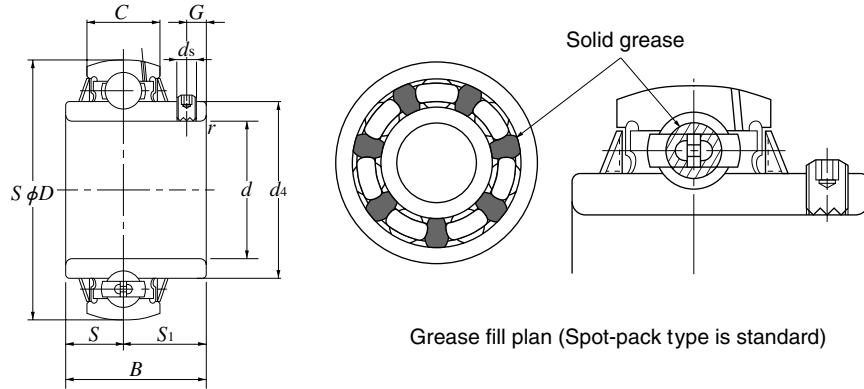

Shaft dia. mm inch	Bearing number	Nominal dimensions										Basic load rating		Mass (Ref.) kg lb
		d	D	B	C	r <sub>s min</sub>	S	S <sub>1</sub>	G	ds	d <sub>4</sub>	N dynamic C <sub>r</sub>	lbf static C <sub>or</sub>	
20 3/4	F-UC204D1/LP03	20	47	31	17	1	12.7	18.3	4.5	M5×0.8	29.6	9 900	6 650	0.17
	F-UC204-012D1/LP03	0.7500	1.8504	1.2205	0.6693	0.039	0.500	0.720	0.177	No.10-32UNF	1.1654	2 220	1 500	0.39
25 13/16 7/8 15/16 1	F-UC205D1/LP03	25	52	34.1	17	1	14.3	19.8	5	M5×0.8	33.9	10 800	7 850	0.20
	F-UC205-013D1/LP03	0.8125												0.53
	F-UC205-014D1/LP03	0.8750	2.0472	1.3425	0.6693	0.039	0.563	0.780	0.197	No.10-32UNF	1.3346	2 430	1 770	0.51
	F-UC205-015D1/LP03	0.9375												0.46
30 1 1/16 1 1/8 1 3/16 1 1/4	F-UC206D1/LP03	30	62	38.1	19	1	15.9	22.2	5	M6×0.75	40.8	15 000	11 300	0.33
	F-UC206-101D1/LP03	1.0625												0.82
	F-UC206-102D1/LP03	1.1250	2.4409	1.5000	0.7480	0.039	0.626	0.874	0.197	1/4-28UNF	1.6063	3 350	2 540	0.77
	F-UC206-103D1/LP03	1.1875												0.73
35 1 1/4 1 5/16 1 3/8 1 7/8	F-UC207D1/LP03	35	72	42.9	20	1.5	17.5	25.4	6	M6×0.75	46.8	19 700	15 300	0.49
	F-UC207-104D1/LP03	1.2500												1.21
	F-UC207-105D1/LP03	1.3125	2.8346	1.6890	0.7874	0.059	0.689	1.000	0.236	1/4-28UNF	1.8425	4 450	3 450	1.15
	F-UC207-106D1/LP03	1.3750												1.08
40 1 1/2 1 9/16	F-UC208D1/LP03	40	80	49.2	21	1.5	19	30.2	8	M8×1	53	22 400	17 800	0.65
	F-UC208-108D1/LP03	1.5000	3.1496	1.9370	0.8268	0.059	0.748	1.189	0.315	5/16-24UNF	2.0866	5 050	4 000	1.52
	F-UC208-109D1/LP03	1.5625												1.46

Note) Insert bearings can be supplied with USDA qualified food grade grease. The resulting grease suffix is "L596". Ex. F-UC204 D1/L596.

Grease name	Allowable temp. range.	Applications	Note
CALTEX FM Grease EP2	-20~+80°C	Food processing and general machines.	H-1 standard grease qualified by USDA.

## Unit ball bearing tolerances (JIS B 1558)

### 1. Inner ring tolerances.

Unit:  $\mu\text{m}/0.0001$  inch

Nominal bore diameter				Bore diameter			Width			Radial runout (ref.)
d				$\Delta d_{mp}$		$\Delta V_{dp}$	$\Delta B_s$		Deviations (ref.)	
over	incl.	high	low	max.	high	low	max.			
18	0.7087	31.750	1.2500	+18	0	12	0	-120	18	
				+7	0	5	0	-47	7	
31.750	1.2500	50.800	2.0000	+21	0	14	0	-120	20	
				+8	0	6	0	-47	8	

$\Delta d_{mp}$ ; Mean bore diameter deviation.  $\Delta V_{dp}$ ; Bore diameter variation.  
 $\Delta B_s$ ; Inner ring width deviation.

### 2. Outer ring tolerances.

Unit:  $\mu\text{m}/0.0001$  inch

Nominal outside diameter				$\Delta D_m$		Radial runout (ref.)
D				Deviations		
over	incl.	high	low	max.		
30	1.1811	50	1.9685	0	-11	20
				0	-4	8
50	1.9685	80	3.1496	0	-13	25
				0	-5	10

$\Delta D_m$ ; Mean outside diameter deviation.  
The low deviation of outside diameter  $\Delta D_m$  dose not apply within the distance of 1/4 the width of the outer ring from the side.

## Attaching the dust cover

- ① Insert the edge of the dust cover in the housing's groove.
- ② Insert the other side of the dust cover in the opposite housing groove either by hand or with assistance of a plastic/rubber mallet/hammer.
- ③ To remove the dust cover, pry the edge from the housing groove using a screw driver or similar tool.

\* Note: frequent mounting/dismounting of the dust cover may damage the edge of the housing and is not recommended.

