

Spherical Roller Bearings



1. Types, design features, and characteristics

Spherical roller bearings consist of an outer ring having a continuous spherical raceway and two rows of barrel-shaped rollers guided by an inner ring with two raceways (see Fig. 1). This bearing has self-aligning properties, and therefore is suited for use where misalignment between the inner and outer rings occurs from housing installation error or shaft bending.

Spherical roller bearings have a large capacity for radial loads, axial loads in either direction, and combined loads. They are also suited for applications where vibration and shock loads are encountered. When spherical roller bearings are used with a vertical shaft or under a large axial load, the load on the rollers of the row that is not subject to the axial load becomes small, and the resulting skidding on the rollers may result in wear. If the ratio of the axial load to the radial load exceeds the factor e in the dimension table ($F_a/F_r > e$), consult NTN Engineering.

In addition to spherical roller bearings with cylindrical bores, spherical roller bearings with tapered bores are also available. Bearings with tapered bores are specified by the suffix "K" at the end of the spherical roller bearing part number. The standard taper ratio is 1:12 for bearings with a "K" suffix; for bearings in series 240 and 241, the suffix "K30" indicates the taper ratio for a bearing is 1:30. Most tapered bore bearings incorporate the use of adapters and withdrawal sleeves for shaft mounting.

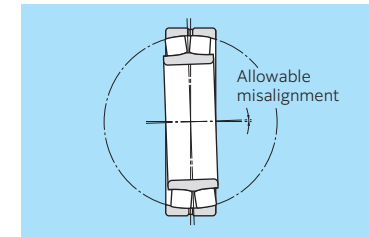

Fig. 1

Table 1 Types of spherical roller bearings

Type	ULTAGE series ¹⁾		
	Type EA	Type EM	Type EM (large size)
Design			
Bearing series	Series other than 213 with outside diameter of 420 mm or smaller		Series with outside diameter of 440 to 580 mm
Rollers	Symmetrical		
Cage type	Pressed cage	Machined cage	Machined cage
Cage shape			
Max. operating temperature	200 °C		
Type	Type B	Type 213C	Type 213
Design			
Bearing series	Other than ULTAGE series (outside diameter of 300 mm or larger)	Series 213 with bore diameter of 50 mm or smaller	Series 213 with bore diameter of 55 mm or larger
Rollers	Asymmetrical	Symmetrical	Asymmetrical
Cage type	Machined cage	Pressed cage	Machined cage
Cage shape			
Max. operating temperature	120 °C (instantaneous)		100 °C (continuous)

1) ULTAGE series spherical roller bearings are the products developed to meet the demands of "long operating life," "higher speed," and "improved easy handling" that are required for various industrial machinery.
For details, see the special catalog "ULTAGE series Spherical Roller Bearings [Type EA, Type EM] (CAT. No. 3033/E)."

2. ULTAGE series fits

Table 2 Shaft tolerance class in common use

Conditions	Shaft diameter (mm)		Shaft tolerance class	Remarks	
	Over	Incl.			
Cylindrical bore bearing (Class 0)					
Inner ring rotational load or load of undetermined direction	Light load ¹⁾ or Normal load ¹⁾ or Fluctuating load	18	25	k5	
		25	40	m5	
Static inner ring load	Heavy load ¹⁾ or Impact load	40	60	n5	
		60	100	n6	
		100	200	p6	
		200	500	r6	
Tapered bore bearing (Class 0) (with adapter or withdrawal sleeve)					
Full load	Overall shaft diameter		h9/IT5 ³⁾	h10/IT7 ³⁾ will suffice for power transmitting shafts.	

1) Standards for light loads, normal loads, and heavy loads

- Light loads: dynamic equivalent radial load $\leq 0.05C_r$
- Normal loads: $0.05C_r < \text{dynamic equivalent radial load} \leq 0.10C_r$
- Heavy loads: $0.10C_r < \text{dynamic equivalent radial load}$

2) When the shaft diameter exceeds $\phi 200$ mm and the bearing is to be used under heavy load or impact load conditions, please consult NTN Engineering.

3) The shaft shape error (roundness, cylindricity, etc.) must be within the tolerance range of IT5 and IT7.

Note: 1. All values and fits listed in the above tables are for solid steel shafts.

2. Use the formula below to calculate necessary interference. The upper limit value should not exceed 1/1 000 of the shaft diameter.

$$\begin{cases} \text{When } F_r \leq 0.3C_{0r}, \text{ necessary interference } \Delta_{dF} (\mu\text{m}) \text{ is } \Delta_{dF} = 0.08 (d \cdot F_r/B)^{1/2} \\ \text{When } F_r > 0.3C_{0r}, \Delta_{dF} = 0.02 (F_r/B) \end{cases}$$

[d : bearing bore diameter (mm), B : inner ring width (mm), F_r : radial load, (N), C_{0r} : basic static rating load (N)]

When the difference between the bearing temperature and the ambient temperature during bearing operation is to be considered, consider the effective interference Δ_{dT} (μm) by the temperature difference as the necessary interference.

$$\Delta_{dT} = 0.0015 \cdot d \cdot \Delta T$$

(ΔT : Difference between bearing temperature and ambient temperature °C)

Table 3 Housing bore tolerance class in common use

Housing	Conditions		Housing bore tolerance class	Remarks
	Load type, etc.	Outer ring axial direction movement		
Single housing or split housing	Static outer ring load	All types of loads	Yes	H7 G7 can be used for large bearings or bearings with a large temperature differential between the outer ring and housing.
		Light ¹⁾ or ordinary load ¹⁾	Yes	H8 —
		Shaft and inner ring become hot.	Easily	G7 F7 can be used for large bearings or bearings with a large temperature differential between the outer ring and housing.
Single housing	Indeterminate load	Requires precise rotation under light or ordinary loads.	As a rule, it cannot move.	K6 —
			Yes	JS6 —
		Requires low noise operation.	Yes	H6 —
	Indeterminate load	Light or ordinary load	Yes	JS7 —
		Ordinary or heavy load ¹⁾	As a rule, it cannot move.	K7 —
	Rotating outer ring load	High impact load	No	M7 —
		Light or fluctuating load	No	M7 —
Ordinary or heavy load		No	N7 —	
		Heavy load or large impact load with thin wall housing	No	P7 —

1) Standards for light loads, normal loads, and heavy loads

- Light loads: $\text{dynamic equivalent radial load} \leq 0.05C_r$
- Normal loads: $0.05C_r < \text{dynamic equivalent radial load} \leq 0.10C_r$
- Heavy loads: $0.10C_r < \text{dynamic equivalent radial load}$

Note: All values and fits listed in the above tables are for cast iron or steel housings.

3. Allowable speed of ULTAGE series

As the rotational speed of the bearing increases, the temperature of the bearing also increases because of the friction heat produced inside the bearing. Excessive heat will significantly deteriorate the bearing performance, causing abnormal temperature rises and seizure.

Factors affecting the allowable speed of bearings are as follows.

- (1) Bearing type
- (2) Bearing size
- (3) Lubrication (grease lubrication, circulating lubrication, oil lubrication, etc.)
- (4) Bearing internal clearance (bearing internal clearance during operation)
- (5) Bearing load
- (6) Shaft and housing accuracy

The allowable speed specified in the bearing dimension table is the limit for heat dissipation and satisfactory lubrication conditions before the bearing is adversely affected.

The allowable speed of ULTAGE series spherical roller bearings specified in the catalog is defined as follows.

[Oil lubrication]

The allowable speed for oil lubrication is the speed at which the outer ring temperature reaches 80 °C with room temperature spindle oil (lubrication oil viscosity: ISO VG32) supplied at 1 liter/min under an operating load of 5 % of the basic static load rating C_{0r} .

[Grease lubrication]

The allowable speed for grease lubrication is the speed at which the outer ring temperature reaches 80 °C with lithium-based grease (consistency: NLGI3) filled 20 to 30 % of the free space under an operating load of 5 % of the basic static load rating C_{0r} .

In either of the lubrication methods, the bearing temperature rise differs if the usage condition (operating load, rotational speed pattern, lubricating condition, etc.) is different; therefore, the bearings must be selected with sufficient allowable speed as specified in the catalog.

If 80 % of the allowable speed specified in the dimension table is exceeded or the bearing is used in vibration or impact conditions, please consult **NTN** Engineering.

See section "9. Allowable speed" for the allowable speed of the spherical roller bearings that are not part of the ULTAGE series.

4. Oil inlet and groove for outer ring

Both ULTAGE series and type B spherical roller bearings are provided with oil inlets and an oil groove (see Fig. 2 and Table 4).

Types 213 and C do not have oil inlets and grooves. However, they can be made based on customer request. Contact NTN Engineering with the bearing numbers and supplementary suffix code "D1" (refer to page A-48).

If a pin to prevent outer ring rotation is necessary, contact NTN Engineering.

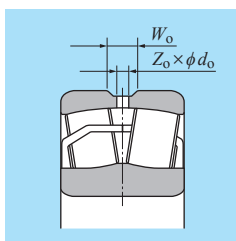

Fig. 2

Table 4 Oil inlet number

Nominal bearing outside diameter D mm		Number of oil inlets	
		D1	W33 (Made in Europe)
Incl.	Below	Z_o	Z_o
—	320	4	3
320	1 010	8	3
1 010	—	12	—

For oil groove width W_o and diameter of oil inlet d_o , see the dimension table.

5. Allowable misalignment angle

Spherical roller bearings have the same self-aligning properties as other self-aligning bearings. The allowable misalignment angle varies according to dimension series and load conditions, but the general allowable misalignment angles are listed below:

- Normal load or more:1/115
- Light load:1/30

* Increasing the misalignment angle beyond the allowable angle may cause the rollers to protrude from the outer ring and interfere with nearby components.

6. Adapters and withdrawal sleeves

Adapters are used for installation of bearings with tapered bores on cylindrical shafts (see Fig. 3). Withdrawal sleeves are also used to install and disassemble bearings with tapered bores onto and off of cylindrical shafts (see Fig. 4). In disassembling the bearing from the shaft, the nut is turned against the side face of the inner ring utilizing the bolt provided on the withdrawal sleeve, and then the sleeve is drawn away from the bearing's bore. (Precision and dimensions of adapter and withdrawal sleeve are defined in JIS B 1552 and JIS B 1556).

For bearings with a bore diameter of 200 mm or more, high pressure oil (hydraulic) type adapters and withdrawal sleeves can be made to make installation and disassembly easier. As shown in Fig. 5 construction is designed to reduce friction by injecting high pressure oil between the surfaces of the adapter sleeve and bearing inner bore by means of a pressure fitting.

If the oil supply inlet is attached in the nut side of the adapter, the supplementary suffix "HF" is added to the bearing number; if the oil supply inlet is attached on the opposite side, the suffix "HB" is added to the bearing number. For adapter sleeves, the supplementary suffix "H" is added to the bearing's number for both cases. The hydraulic sleeve nut is equipped with holes for bolts used for mounting and dismounting and holes for hydraulic piping. The suffix SP (with screw holes) or SPB (with bolts) is added to the bearing number of the nut.

For information on the **hydraulic adapters and withdrawal sleeves**, see the special catalog "Adapters, Withdrawal Sleeves, Locknuts, Lockwashers & Lockplates, Hydraulic Nuts (CAT. No. 4201/E)."

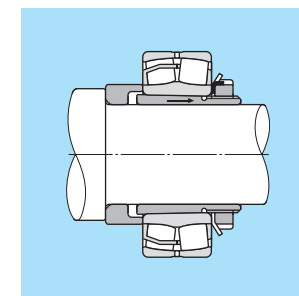

Fig. 3

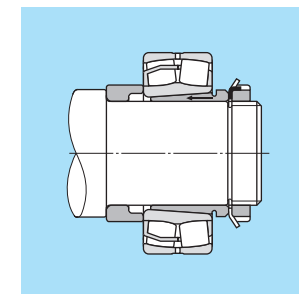

Fig. 4

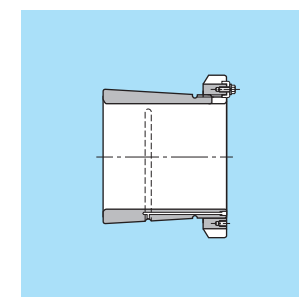
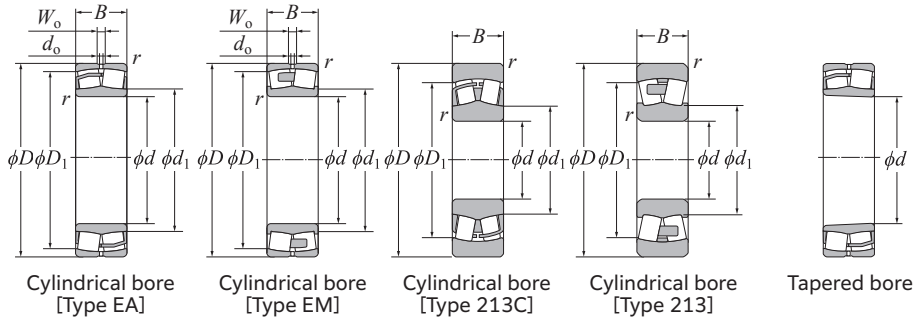
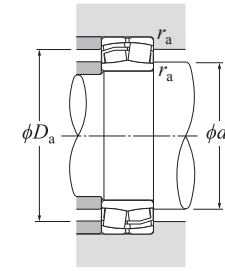

Fig. 5

Spherical Roller Bearings



Spherical Roller Bearings



Dynamic equivalent radial load

$$P_r = XF_r + YF_a$$

$\frac{F_a}{F_r} \leq e$		$\frac{F_a}{F_r} > e$	
X	Y	X	Y
1	Y_1	0.67	Y_2

Static equivalent radial load

$$P_{0r} = F_r + Y_0 F_a$$

For values of e , Y_1 , Y_2 and Y_0 see the table below.

d 25–60 mm

Boundary dimensions	Basic load rating		Fatigue load limit	Allowable speed		Bearing numbers ^{1) 4)}	
	dynamic	static		min ⁻¹		Cylindrical bore	Tapered bore ²⁾
mm	kN	kN	min ⁻¹	min ⁻¹			
d D B $r_{s \min}^{(3)}$ W_0 d_o C_r C_{0r} C_u			Grease lubrication	Oil lubrication			
25	52 18 1 3 1.5	57.3	46.1	3.23	10 400	13 000	*22205EAW33 *22205EAKW33
	52 18 1 3 1.5	57.3	46.1	3.23	10 400	13 000	*22205EMW33 *22205EMKW33
30	62 20 1 4 2	75.7	64.5	4.58	8 800	11 000	*22206EAW33 *22206EAKW33
	62 20 1 4 2	75.7	64.5	4.58	8 800	11 000	*22206EMW33 *22206EMKW33
35	72 23 1.1 5 2	100	92.0	6.11	7 500	9 400	*22207EAW33 *22207EAKW33
	72 23 1.1 5 2	100	92.0	6.11	7 500	9 400	*22207EMW33 *22207EMKW33
40	80 23 1.1 5 2.5	116	105	7.78	6 800	8 500	*22208EAD1 *22208EAKD1
	80 23 1.1 5 2.5	110	98.0	7.29	6 800	8 500	*22208EMD1 *22208EMKD1
	90 23 1.5 6 3	98.0	90.0	12.6	4 900	6 400	21308C 21308CK
	90 33 1.5 6 3	169	152	9.36	5 400	6 600	*22308EAD1 *22308EAKD1
	90 33 1.5 6 3	169	152	9.36	5 400	6 600	*22308EMD1 *22308EMKD1
45	85 23 1.1 6 2.5	121	113	8.76	6 100	7 700	*22209EAD1 *22209EAKD1
	85 23 1.1 6 2.5	116	106	8.24	6 100	7 700	*22209EMD1 *22209EMKD1
	100 25 1.5 6 3	114	106	14.1	4 400	5 700	21309C 21309CK
	100 36 1.5 6 3	206	187	11.8	4 600	5 700	*22309EAD1 *22309EAKD1
	100 36 1.5 6 3	206	187	11.8	4 600	5 700	*22309EMD1 *22309EMKD1
50	90 23 1.1 6 2.5	130	124	10.1	5 700	7 200	*22210EAD1 *22210EAKD1
	90 23 1.1 6 2.5	125	117	9.54	5 700	7 200	*22210EMD1 *22210EMKD1
	110 27 2 6 3	131	127	13.7	4 000	5 200	21310C
	110 40 2 7 3.5	250	232	14.0	4 300	5 300	*22310EAD1 *22310EAKD1
110 40 2 7 3.5	250	232	14.0	4 300	5 300	*22310EMD1 *22310EMKD1	
55	100 25 1.5 6 3	155	148	12.6	5 300	6 700	*22211EAD1 *22211EAKD1
	100 25 1.5 6 3	148	140	11.9	5 300	6 700	*22211EMD1 *22211EMKD1
	120 29 2 6 3	161	163	16.1	3 700	4 800	21311K
	120 43 2 8 3.5	296	274	17.4	3 900	4 800	*22311EAD1 *22311EAKD1
120 43 2 8 3.5	296	274	17.4	3 900	4 800	*22311EMD1 *22311EMKD1	
60	110 28 1.5 7 3	187	181	15.4	4 800	6 000	*22212EAD1 *22212EAKD1
	110 28 1.5 7 3	179	171	14.6	4 800	6 000	*22212EMD1 *22212EMKD1
	130 31 2.1 7 4	186	191	28.2	3 400	4 400	21312 21312K
	130 46 2.1 9 4	340	319	20.3	3 600	4 600	*22312EAD1 *22312EAKD1
	130 46 2.1 9 4	340	319	20.3	3 600	4 600	*22312EMD1 *22312EMKD1

1) Bearing numbers with * are ULTAGE series and have outer ring oil inlets and oil grooves as standard.
 2) "K" indicates bearings having a tapered bore with a taper ratio of 1:12. 3) Smallest allowable dimension for chamfer dimension r .
 4) "W33" indicates the made in Europe and have three oil inlets.

Installation-related dimensions					Constant	Axial load factors			Mass (approx.)	
d_1	d_a Min.	mm D_a Max.	D_1	r_{as} Max.	e	Y_1	Y_2	Y_0	Cylindrical bore	Tapered bore
									kg	kg
30	30	46	46	1	0.34	2.00	2.98	1.96	0.173	0.169
30	30	46	46	1	0.34	2.00	2.98	1.96	0.174	0.171
37	36	56	55	1	0.31	2.15	3.20	2.10	0.278	0.272
37	36	56	55	1	0.31	2.15	3.20	2.10	0.281	0.275
45	42	65	63	1.1	0.31	2.21	3.29	2.16	0.438	0.43
45	42	65	63	1.1	0.31	2.21	3.29	2.16	0.442	0.433
50	47	73	71	1.1	0.27	2.47	3.67	2.41	0.528	0.518
50	47	73	71	1.1	0.27	2.47	3.67	2.41	0.529	0.519
52	48.5	81.5	76	1.5	0.26	2.55	3.80	2.50	0.705	0.694
52	49	81	78	1.5	0.36	1.87	2.79	1.83	1.02	1
52	49	81	78	1.5	0.36	1.87	2.79	1.83	1.03	1.01
54	52	78	76	1.1	0.26	2.64	3.93	2.58	0.572	0.561
54	52	78	76	1.1	0.26	2.64	3.93	2.58	0.577	0.566
58	53.5	91.5	85	1.5	0.26	2.60	3.87	2.54	0.927	0.912
58	54	91	87	1.5	0.36	1.90	2.83	1.86	1.37	1.34
58	54	91	87	1.5	0.36	1.90	2.83	1.86	1.38	1.35
59	57	83	81	1.1	0.24	2.84	4.23	2.78	0.614	0.602
59	57	83	81	1.1	0.24	2.84	4.23	2.78	0.616	0.604
65	60	100	93	2	0.26	2.64	3.93	2.58	1.21	1.19
63	61	99	95	2	0.36	1.87	2.79	1.83	1.82	1.79
63	61	99	95	2	0.36	1.87	2.79	1.83	1.84	1.8
66	64	91	90	1.5	0.23	2.95	4.40	2.89	0.83	0.814
66	64	91	90	1.5	0.23	2.95	4.40	2.89	0.827	0.811
73	65	110	102	2	0.25	2.69	4.00	2.63	1.71	1.69
68	66	109	104	2	0.36	1.87	2.79	1.83	2.31	2.26
68	66	109	104	2	0.36	1.87	2.79	1.83	2.34	2.29
71	69	101	99	1.5	0.24	2.84	4.23	2.78	1.14	1.12
71	69	101	99	1.5	0.24	2.84	4.23	2.78	1.15	1.13
78	72	118	109	2	0.25	2.69	4.00	2.63	2.1	2.07
75	72	118	113	2.1	0.35	1.95	2.90	1.91	2.86	2.8
75	72	118	113	2.1	0.35	1.95	2.90	1.91	2.91	2.85

Note: For the bearings other than ULTAGE series, outer rings with oil inlets and oil grooves can also be made based on your request. In this case, supplementary suffix "D1" is added after a bearing number. Example: 21311D1

● Spherical Roller Bearings

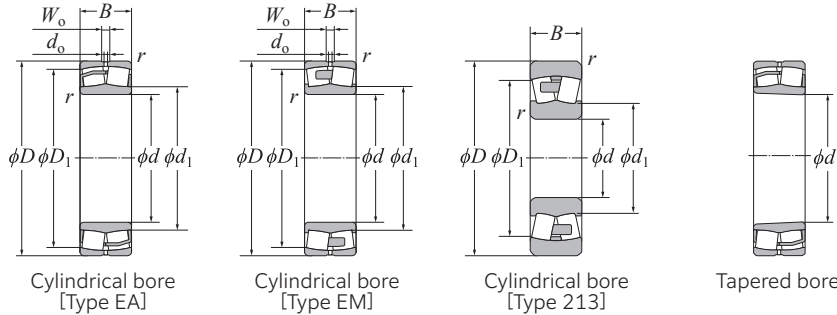

d 65-95 mm

Boundary dimensions	Basic load rating					Fatigue load limit	Allowable speed		Bearing numbers ¹⁾		
	dynamic						min ⁻¹	Oil lubrication	Cylindrical bore	Tapered bore ²⁾	
mm	<i>C_r</i>	<i>C_{0r}</i>	<i>C_u</i>	<i>C₁₀</i>	<i>C₅₀</i>	Grease lubrication					
65	120 31	1.5	8	3.5	226	224	18.2	4 400	5 500	*22213EAD1	*22213EAKD1
	120 31	1.5	8	3.5	217	212	17.2	4 400	5 500	*22213EMD1	*22213EMKD1
	140 33	2.1	7	4	216	228	31.0	3 100	4 000	21313	21313K
	140 48	2.1	9	4	369	343	23.4	3 300	4 100	*22313EAD1	*22313EAKD1
	140 48	2.1	9	4	369	343	23.4	3 300	4 100	*22313EMD1	*22313EMKD1
70	125 31	1.5	7	3.5	235	240	20.1	4 100	5 200	*22214EAD1	*22214EAKD1
	125 31	1.5	7	3.5	235	240	20.1	4 100	5 200	*22214EMD1	*22214EMKD1
	150 35	2.1	7	4	245	262	33.5	2 900	3 800	21314	21314K
	150 51	2.1	10	5	420	396	26.0	3 000	3 800	*22314EAD1	*22314EAKD1
	150 51	2.1	10	5	420	396	26.0	3 000	3 800	*22314EMD1	*22314EMKD1
75	130 31	1.5	7	3.5	244	249	21.1	4 000	5 000	*22215EAD1	*22215EAKD1
	130 31	1.5	7	3.5	244	249	21.1	4 000	5 000	*22215EMD1	*22215EMKD1
	160 37	2.1	7	4	266	287	27.5	2 700	3 500	21315	21315K
	160 55	2.1	10	5	491	467	29.8	2 900	3 600	*22315EAD1	*22315EAKD1
	160 55	2.1	10	5	491	467	29.8	2 900	3 600	*22315EMD1	*22315EMKD1
80	140 33	2	8	3.5	278	287	24.0	3 700	4 600	*22216EAD1	*22216EAKD1
	140 33	2	8	3.5	267	272	22.8	3 700	4 600	*22216EMD1	*22216EMKD1
	170 39	2.1	7	4	289	315	30.5	2 500	3 300	21316	21316K
	170 58	2.1	10	5	541	522	32.5	2 700	3 400	*22316EAD1	*22316EAKD1
	170 58	2.1	10	5	541	522	32.5	2 700	3 400	*22316EMD1	*22316EMKD1
85	150 36	2	8	3.5	324	330	27.1	3 400	4 300	*22217EAD1	*22217EAKD1
	150 36	2	8	3.5	324	330	27.1	3 400	4 300	*22217EMD1	*22217EMKD1
	180 41	3	7	4	320	355	45.0	2 400	3 100	21317	21317K
	180 60	3	11	5	599	604	36.4	2 600	3 200	*22317EAD1	*22317EAKD1
	180 60	3	11	5	599	604	36.4	2 600	3 200	*22317EMD1	*22317EMKD1
90	160 40	2	10	4.5	384	398	30.2	3 200	4 000	*22218EAD1	*22218EAKD1
	160 40	2	10	4.5	384	398	30.2	3 200	4 000	*22218EMD1	*22218EMKD1
	160 52.4	2	9	4	467	513	30.0	2 600	3 200	*23218EMD1	*23218EMKD1
	190 43	3	7	4	355	400	50.5	2 300	3 000	21318	21318K
	190 64	3	12	5	668	652	40.0	2 500	3 000	*22318EAD1	*22318EAKD1
	190 64	3	12	5	668	652	40.0	2 500	3 000	*22318EMD1	*22318EMKD1
95	170 43	2.1	10	4.5	416	417	33.4	3 000	3 800	*22219EAD1	*22219EAKD1
	170 43	2.1	10	4.5	416	417	33.4	3 000	3 800	*22219EMD1	*22219EMKD1

1) Bearing numbers with * are ULTAGE series and have outer ring oil inlets and oil grooves as standard.
 2) "K" indicates bearings having a tapered bore with a taper ratio of 1:12. 3) Smallest allowable dimension for chamfer dimension r.

● Spherical Roller Bearings

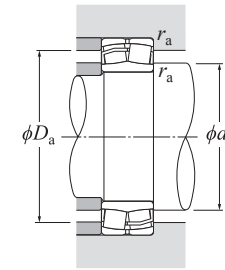

Dynamic equivalent radial load

$$P_r = X F_r + Y F_a$$

$\frac{F_a}{F_r} \leq e$		$\frac{F_a}{F_r} > e$	
X	Y	X	Y
1	Y ₁	0.67	Y ₂

Static equivalent radial load

$$P_{0r} = F_r + Y_0 F_a$$

For values of e, Y₁, Y₂ and Y₀ see the table below.

Installation-related dimensions					Constant	Axial load factors			Mass (approx.)	
<i>d</i> ₁	<i>d</i> _a Min.	mm <i>D</i> _a Max.	<i>D</i> ₁	<i>r</i> _{as} Max.		<i>e</i>	Y ₁	Y ₂	Y ₀	Cylindrical bore
78	74	111	107	1.5	0.24	2.79	4.15	2.73	1.52	1.49
78	74	111	107	1.5	0.24	2.79	4.15	2.73	1.53	1.5
85	77	128	119	2	0.25	2.69	4.00	2.63	2.55	2.51
81	77	128	122	2.1	0.33	2.06	3.06	2.01	3.48	3.41
81	77	128	122	2.1	0.33	2.06	3.06	2.01	3.5	3.43
84	79	116	113	1.5	0.22	3.01	4.48	2.94	1.61	1.58
84	79	116	113	1.5	0.22	3.01	4.48	2.94	1.64	1.6
91	82	138	126	2	0.25	2.69	4.00	2.63	3.18	3.14
85	82	138	131	2.1	0.34	2.00	2.98	1.96	4.25	4.16
85	82	138	131	2.1	0.34	2.00	2.98	1.96	4.31	4.22
88	84	121	118	1.5	0.22	3.14	4.67	3.07	1.67	1.64
88	84	121	118	1.5	0.22	3.14	4.67	3.07	1.71	1.67
99	87	148	136	2	0.24	2.84	4.23	2.78	3.81	3.76
91	87	148	139	2.1	0.34	2.00	2.98	1.96	5.18	5.07
91	87	148	139	2.1	0.34	2.00	2.98	1.96	5.27	5.16
94	91	129	127	2	0.22	3.14	4.67	3.07	2.09	2.05
94	91	129	127	2	0.22	3.14	4.67	3.07	2.11	2.07
105	92	158	144	2	0.23	2.95	4.40	2.89	4.53	4.47
98	92	158	148	2.1	0.34	2.00	2.98	1.96	6.12	5.99
98	92	158	148	2.1	0.34	2.00	2.98	1.96	6.28	6.15
100	96	139	137	2	0.22	3.07	4.57	3.00	2.59	2.54
100	96	139	137	2	0.22	3.07	4.57	3.00	2.67	2.62
111	99	166	152	2.5	0.25	2.69	4.00	2.63	5.35	5.28
107	99	166	157	3	0.32	2.09	3.11	2.04	7.18	7.04
107	99	166	157	3	0.32	2.09	3.11	2.04	7.29	7.15
105	101	149	144	2	0.23	2.90	4.31	2.83	3.34	3.27
105	101	149	144	2	0.23	2.90	4.31	2.83	3.43	3.37
104	101	149	141	2	0.30	2.25	3.34	2.20	4.43	4.31
119	104	176	162	2.5	0.24	2.84	4.23	2.78	6.3	6.21
110	104	176	166	3	0.33	2.06	3.06	2.01	8.42	8.25
110	104	176	166	3	0.33	2.06	3.06	2.01	8.53	8.35
110	107	158	153	2.1	0.23	2.95	4.40	2.89	3.98	3.9
110	107	158	153	2.1	0.23	2.95	4.40	2.89	4.06	3.98

Note: For the bearings other than ULTAGE series, outer rings with oil inlets and oil grooves can also be made based on your request. In this case, supplementary suffix "D1" is added after a bearing number. Example: 21317D1

● Spherical Roller Bearings

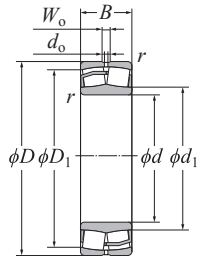

Cylindrical bore
[Type EA]

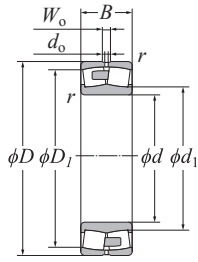

Cylindrical bore
[Type EM]

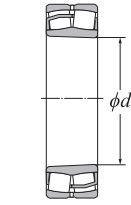

Tapered bore

d 160–190 mm

d	Boundary dimensions					Basic load rating		Fatigue load limit kN C _u	Allowable speed		Bearing numbers ¹⁾	
	D	B	r _{s min} ³⁾	W ₀	d _o	dynamic kN C _r	static kN C _{0r}		min ⁻¹ Grease lubrication	Oil lubrication	Cylindrical bore	Tapered bore ²⁾
160	270	109	2.1	14	6	1360	1860	70.6	1500	1800	*24132EMD1	*24132EMK30D1
	290	80	3	17	8	1220	1390	84.1	1700	2100	*22232EAD1	*22232EAKD1
	290	80	3	17	8	1220	1390	84.1	1700	2100	*22232EMD1	*22232EMKD1
	290	104	3	15	7	1550	1890	83.8	1400	1800	*23232EMD1	*23232EMKD1
	340	114	4	20	10	1950	2210	109	1300	1600	*22332EMD1	*22332EMKD1
170	230	45	2	9	4.5	468	723	48.8	1800	2300	*23934EMD1	*23934EMKD1
	260	67	2.1	12	5	914	1240	68.8	1700	2200	*23034EAD1	*23034EAKD1
	260	67	2.1	12	5	914	1240	68.8	1700	2200	*23034EMD1	*23034EMKD1
	260	90	2.1	11	5	1100	1600	66.3	1500	1900	*24034EMD1	*24034EMK30D1
	280	88	2.1	14	6	1270	1700	77.3	1400	1800	*23134EAD1	*23134EAKD1
	280	88	2.1	14	6	1270	1700	77.3	1400	1800	*23134EMD1	*23134EMKD1
	280	109	2.1	14	6	1410	1990	74.4	1400	1700	*24134EMD1	*24134EMK30D1
	310	86	4	18	8	1400	1610	94.7	1600	2000	*22234EMD1	*22234EMKD1
	310	110	4	16	8	1700	2070	94.6	1300	1700	*23234EMD1	*23234EMKD1
360	120	4	20	10	2200	2630	121	1200	1500	*22334EMD1	*22334EMKD1	
180	250	52	2	10	5	573	869	57.2	1700	2100	*23936EMD1	*23936EMKD1
	280	74	2.1	13	6	1080	1450	78.6	1600	2000	*23036EAD1	*23036EAKD1
	280	74	2.1	13	6	1080	1450	78.6	1600	2000	*23036EMD1	*23036EMKD1
	280	100	2.1	13	6	1310	1880	76.0	1400	1800	*24036EMD1	*24036EMK30D1
	300	96	3	15	7	1490	1960	88.7	1300	1700	*23136EAD1	*23136EAKD1
	300	96	3	15	7	1490	1960	88.7	1300	1700	*23136EMD1	*23136EMKD1
	300	118	3	15	7	1660	2290	85.5	1300	1600	*24136EMD1	*24136EMK30D1
	320	86	4	18	8	1450	1660	101	1500	1900	*22236EMD1	*22236EMKD1
	320	112	4	16	8	1800	2270	101	1200	1600	*23236EMD1	*23236EMKD1
380	126	4	21	10	2420	2810	132	1100	1400	*22336EMD1	*22336EMKD1	
190	260	52	2	10	5	603	935	62.8	1600	2000	*23938EMD1	*23938EMKD1
	290	75	2.1	13	6	1140	1570	83.5	1500	1900	*23038EAD1	*23038EAKD1
	290	75	2.1	13	6	1140	1570	83.5	1500	1900	*23038EMD1	*23038EMKD1
	290	100	2.1	13	6	1360	2000	80.7	1300	1700	*24038EMD1	*24038EMK30D1
	320	104	3	17	8	1670	2250	100	1200	1600	*23138EMD1	*23138EMKD1
	320	128	3	16	8	1900	2700	96.8	1200	1500	*24138EMD1	*24138EMK30D1
	340	92	4	20	9	1620	1870	112	1400	1800	*22238EMD1	*22238EMKD1
	340	120	4	18	8	1990	2480	109	1200	1500	*23238EMD1	*23238EMKD1
	400	132	5	21	10	2600	3120	145	1000	1300	*22338EMD1	*22338EMKD1

1) Bearing numbers with * are ULTAGE series and have outer ring oil inlets and oil grooves as standard. 2) Bearings appended with "K" have a tapered bore ratio of 1:12; bearings appended with "K30" have a tapered bore ratio of 1:30. 3) Smallest allowable dimension for chamfer dimension r.

● Spherical Roller Bearings

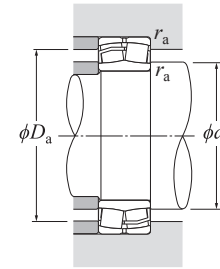

Dynamic equivalent radial load

$$P_r = X F_r + Y F_a$$

$\frac{F_a}{F_r} \leq e$		$\frac{F_a}{F_r} > e$	
X	Y	X	Y
1	Y ₁	0.67	Y ₂

Static equivalent radial load

$$P_{0r} = F_r + Y_0 F_a$$

For values of e, Y₁, Y₂ and Y₀ see the table below.

Installation-related dimensions					Constant	Axial load factors			Mass (approx.)	
d ₁	d _a Min.	mm D _a Max.	D ₁	r _{as} Max.	e	Y ₁	Y ₂	Y ₀	Cylindrical bore	Tapered bore
181	172	258	232	2.1	0.37	1.83	2.72	1.79	25.4	25.1
190	174	276	260	3	0.25	2.69	4.00	2.63	22.3	21.8
190	174	276	260	3	0.25	2.69	4.00	2.63	22.9	22.4
187	174	276	254	3	0.33	2.03	3.02	1.98	29.6	28.8
205	177	323	296	4	0.33	2.03	3.02	1.98	50.5	49.5
185	179	221	215	2	0.16	4.11	6.12	4.02	5.39	5.23
190	181	249	238	2.1	0.22	3.07	4.57	3.00	12.7	12.3
190	181	249	238	2.1	0.22	3.07	4.57	3.00	12.8	12.4
186	181	249	231	2.1	0.30	2.23	3.32	2.18	17.2	16.9
195	182	268	250	2.1	0.28	2.39	3.56	2.34	21.5	20.9
195	182	268	250	2.1	0.28	2.39	3.56	2.34	21.6	20.9
193	182	268	243	2.1	0.35	1.91	2.85	1.87	26.7	26.3
201	187	293	277	4	0.26	2.60	3.87	2.54	28.3	27.7
199	187	293	272	4	0.33	2.03	3.02	1.98	35.8	34.8
223	187	343	313	4	0.32	2.09	3.11	2.04	60.3	59.1
199	189	241	232	2	0.17	3.90	5.81	3.81	7.79	7.56
201	191	269	255	2.1	0.23	2.95	4.40	2.89	16.8	16.3
201	191	269	255	2.1	0.23	2.95	4.40	2.89	16.9	16.4
199	191	269	248	2.1	0.31	2.15	3.20	2.10	22.8	22.4
205	194	286	267	3	0.29	2.32	3.45	2.26	27.2	26.4
205	194	286	267	3	0.29	2.32	3.45	2.26	27.4	26.5
202	194	286	259	3	0.36	1.87	2.79	1.83	33.5	33
209	197	303	287	4	0.25	2.74	4.08	2.68	29.3	28.7
210	197	303	282	4	0.33	2.06	3.06	2.01	38.2	37.1
229	197	363	329	4	0.32	2.09	3.11	2.04	70.2	68.7
209	199	251	243	2	0.17	4.05	6.04	3.96	8.2	7.96
213	201	279	266	2.1	0.22	3.01	4.48	2.94	17.8	17.3
213	201	279	266	2.1	0.22	3.01	4.48	2.94	17.9	17.4
209	201	279	258	2.1	0.30	2.23	3.32	2.18	23.8	23.4
221	204	306	284	3	0.29	2.32	3.45	2.26	34.3	33.2
216	204	306	275	3	0.37	1.84	2.74	1.80	42.1	41.5
222	207	323	305	4	0.25	2.74	4.08	2.68	35.6	34.9
220	207	323	299	4	0.33	2.03	3.02	1.98	46.1	44.7
247	210	380	346	5	0.32	2.12	3.15	2.07	81.5	79.9

Spherical Roller Bearings

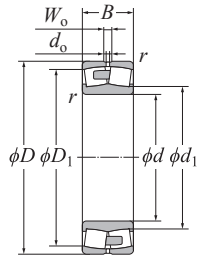

Cylindrical bore
[Type EM]

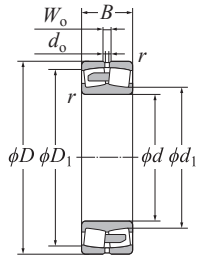

Cylindrical bore
[Type EM (large size)]

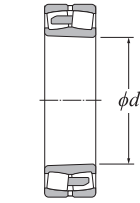

Tapered bore

d 200–280 mm

d	Boundary dimensions					Basic load rating		Fatigue load limit kN C _u	Allowable speed		Bearing numbers ¹⁾	
	D	B	r _{s min} ³⁾	W ₀	d _o	C _r	C _{0r}		min ⁻¹ Grease lubrication	Oil lubrication	Cylindrical bore	Tapered bore ²⁾
200	280	60	2.1	12	6	766	1 190	71.8	1 500	1 900	*23940EMD1	*23940EMKD1
	310	82	2.1	15	7	1 310	1 790	94.1	1 400	1 800	*23040EMD1	*23040EMKD1
	310	109	2.1	14	7	1 570	2 280	91.1	1 200	1 600	*24040EMD1	*24040EMK30D1
	340	112	3	18	8	1 890	2 510	110	1 100	1 400	*23140EMD1	*23140EMKD1
	340	140	3	17	8	2 130	2 930	105	1 100	1 400	*24140EMD1	*24140EMK30D1
	360	98	4	20	10	1 810	2 100	124	1 400	1 700	*22240EMD1	*22240EMKD1
	360	128	4	19	9	2 250	2 840	120	1 100	1 300	*23240EMD1	*23240EMKD1
	420	138	5	21	10	2 830	3 530	158	950	1 200	*22340EMD1	*22340EMKD1
220	300	60	2.1	12	6	789	1 260	79.4	1 400	1 700	*23944EMD1	*23944EMKD1
	340	90	3	15	7	1 530	2 110	109	1 300	1 600	*23044EMD1	*23044EMKD1
	340	118	3	15	7	1 850	2 720	106	1 100	1 400	*24044EMD1	*24044EMK30D1
	370	120	4	19	9	2 190	2 940	128	1 000	1 300	*23144EMD1	*23144EMKD1
	370	150	4	19	9	2 540	3 620	124	1 000	1 300	*24144EMD1	*24144EMK30D1
	400	108	4	21	11	2 210	2 690	149	1 200	1 500	*22244EMD1	*22244EMKD1
	400	144	4	20	10	2 890	3 830	147	1 000	1 200	*23244EMD1	*23244EMKD1
	460	145	5	20	12	3 010	3 560	163	850	1 090	*22344EMD1	*22344EMKD1
240	320	60	2.1	12	6	815	1 350	87.7	1 300	1 600	*23948EMD1	*23948EMKD1
	360	92	3	16	8	1 630	2 350	120	1 100	1 400	*23048EMD1	*23048EMKD1
	360	118	3	16	8	1 940	2 980	116	1 000	1 300	*24048EMD1	*24048EMK30D1
	400	128	4	20	9	2 510	3 500	147	960	1 200	*23148EMD1	*23148EMKD1
	400	160	4	19	9	2 910	4 290	142	960	1 200	*24148EMD1	*24148EMK30D1
	440	120	4	16	10	2 470	3 110	159	1 060	1 350	*22248EMD1	*22248EMKD1
	440	160	4	20	12	3 140	4 260	156	850	1 090	*23248EMD1	*23248EMKD1
	500	155	5	20	12	3 500	4 170	193	780	1 000	*22348EMD1	*22348EMKD1
260	360	75	2.1	14	7	1 130	1 940	105	1 100	1 400	*23952EMD1	*23952EMKD1
	400	104	4	18	8	2 060	2 910	144	1 000	1 300	*23052EMD1	*23052EMKD1
	400	140	4	18	8	2 520	3 820	139	960	1 200	*24052EMD1	*24052EMK30D1
	440	144	4	20	12	2 780	4 020	160	860	1 090	*23152EMD1	*23152EMKD1
	440	180	4	27	16	3 290	4 880	147	850	1 090	*24152EMD1	*24152EMK30D1
	480	130	5	20	12	2 890	3 680	183	970	1 240	*22252EMD1	*22252EMKD1
	480	174	5	27	16	3 650	5 050	180	780	1 000	*23252EMD1	*23252EMKD1
	540	165	6	27	16	4 020	4 830	221	720	920	*22352EMD1	*22352EMKD1
280	380	75	2.1	14	7	1 180	2 050	115	1 000	1 300	*23956EMD1	*23956EMKD1
	420	106	4	18	8	2 170	3 150	155	960	1 200	*23056EMD1	*23056EMKD1

1) Bearing numbers with * are ULTAGE series and have outer ring oil inlets and oil grooves as standard. Bearing models having outside diameter D dimension of 440 mm or more are the type EM (large size). 2) Bearings appended with "K" have a tapered bore ratio of 1:12; bearings appended with "K30" have a tapered bore ratio of 1:30. 3) Smallest allowable dimension for chamfer dimension r.

Spherical Roller Bearings

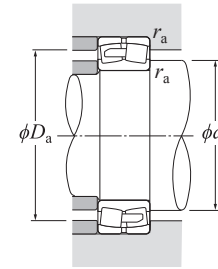

Dynamic equivalent radial load

$$P_r = X F_r + Y F_a$$

$\frac{F_a}{F_r} \leq e$		$\frac{F_a}{F_r} > e$	
X	Y	X	Y
1	Y ₁	0.67	Y ₂

Static equivalent radial load

$$P_{0r} = F_r + Y_0 F_a$$

For values of e, Y₁, Y₂ and Y₀ see the table below.

Installation-related dimensions				Constant	Axial load factors			Mass (approx.)		
d ₁	d _a Min.	D _a Max.	D ₁		r _{as} Max.	e	Y ₁	Y ₂	Y ₀	Cylindrical bore kg
221	211	269	260	2.1	0.18	3.76	5.59	3.67	12	11.6
223	211	299	283	2.1	0.23	2.95	4.40	2.89	22.8	22.1
221	211	299	275	2.1	0.31	2.18	3.24	2.13	30.2	29.7
231	214	326	301	3	0.30	2.25	3.34	2.20	41.9	40.6
224	214	326	291	3	0.39	1.74	2.59	1.70	51.5	50.7
234	217	343	323	4	0.25	2.74	4.08	2.68	42.7	41.8
232	217	343	315	4	0.34	1.98	2.94	1.93	55.2	53.6
265	220	400	364	5	0.31	2.15	3.20	2.10	94.6	92.7
241	231	289	280	2.1	0.17	4.05	6.04	3.96	12.5	12.1
246	233	327	310	3	0.23	2.95	4.40	2.89	29.9	29.1
243	233	327	302	3	0.31	2.20	3.27	2.15	39.2	38.6
252	237	353	328	4	0.30	2.28	3.39	2.23	52.3	50.7
247	237	353	317	4	0.38	1.78	2.65	1.74	65.2	64.3
264	237	383	358	4	0.25	2.74	4.08	2.68	59.6	58.4
261	237	383	349	4	0.34	2.00	2.98	1.96	79.4	77.1
277	240	440	388	5	0.32	2.10	3.13	2.06	119	116
262	251	309	301	2.1	0.15	4.40	6.56	4.31	13.5	13.1
267	253	347	329	3	0.22	3.07	4.57	3.00	32	31.7
264	253	347	322	3	0.28	2.37	3.53	2.32	42.2	41.6
276	257	383	356	4	0.29	2.32	3.45	2.26	65.1	63.1
270	257	383	344	4	0.37	1.82	2.70	1.78	81	79.8
288	257	423	383	4	0.27	2.53	3.77	2.47	82.6	80.9
284	257	423	372	4	0.36	1.86	2.77	1.82	108	105
299	260	480	421	5	0.32	2.12	3.15	2.07	149	146
292	271	349	335	2.1	0.17	3.90	5.81	3.81	23.9	23.1
291	275	385	366	4	0.23	2.95	4.40	2.89	47.8	46.3
286	275	385	354	4	0.31	2.16	3.22	2.12	63.6	62.6
302	277	423	380	4	0.31	2.15	3.20	2.10	92.2	89.5
295	277	423	371	4	0.40	1.69	2.52	1.65	111	109
312	280	460	415	5	0.27	2.53	3.77	2.47	108	105
310	280	460	405	5	0.36	1.87	2.79	1.83	143	139
324	286	514	456	6	0.31	2.16	3.22	2.12	186	183
310	291	369	356	2.1	0.16	4.16	6.20	4.07	25.2	24.4
310	295	405	386	4	0.22	3.07	4.57	3.00	51.3	49.7

Spherical Roller Bearings

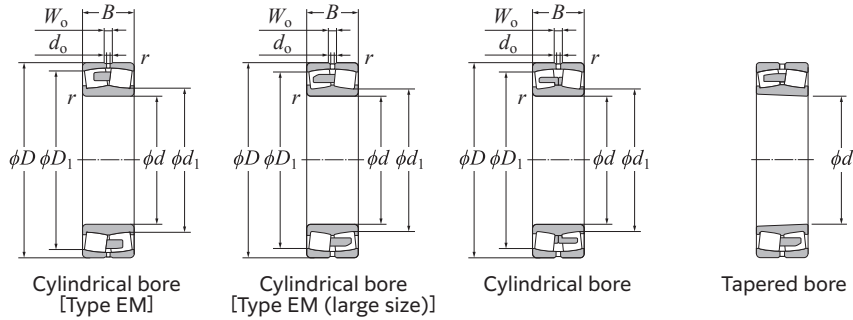

Spherical Roller Bearings

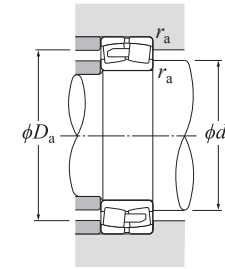

Dynamic equivalent radial load

$$P_r = XF_r + YF_a$$

$\frac{F_a}{F_r} \leq e$		$\frac{F_a}{F_r} > e$	
X	Y	X	Y
1	Y_1	0.67	Y_2

Static equivalent radial load

$$P_{0r} = F_r + Y_0 F_a$$

For values of e , Y_1 , Y_2 and Y_0 see the table below.

d 280–360 mm

d	Boundary dimensions					Basic load rating		Fatigue load limit kN C_u	Allowable speed		Bearing numbers ¹⁾		
	mm					dynamic kN C_r	static kN C_{0r}		min ⁻¹	Grease lubrication	Oil lubrication	Cylindrical bore	Tapered bore ²⁾
	d_1	D	B	$r_{s \min}^{(3)}$	W_0	d_o							
280	420	140	4	18	8	2 620	4 060	150	880	1 100	*24056EMD1	*24056EMK30D1	
	460	146	5	20	12	2 980	4 400	182	810	1 030	*23156EMD1	*23156EMKD1	
	460	180	5	27	16	3 550	5 450	167	810	1 030	*24156EMD1	*24156EMK30D1	
	500	130	5	20	12	3 010	3 920	198	920	1 180	*22256EMD1	*22256EMKD1	
	500	176	5	27	16	3 770	5 340	193	740	950	*23256EMD1	*23256EMKD1	
	580	175	6	27	16	4 490	5 450	249	670	860	*22356EMD1	*22356EMKD1	
	300	420	90	3	14	8	1 600	2 620	145	890	1 140	*23960EMD1	*23960EMKD1
460		118	4	16	10	2 400	3 610	176	890	1 130	*23060EMD1	*23060EMKD1	
460		160	4	20	12	3 150	5 190	166	760	970	*24060EMD1	*24060EMK30D1	
500		160	5	20	12	3 540	5 170	205	750	950	*23160EMD1	*23160EMKD1	
500		200	5	27	16	4 270	6 610	198	750	950	*24160EMD1	*24160EMK30D1	
540		140	5	20	12	3 470	4 590	232	860	1 080	*22260EMD1	*22260EMKD1	
540		192	5	27	16	4 520	6 280	228	690	880	*23260EMD1	*23260EMKD1	
620		185	7.5	27	16	4 000	5 400	490	550	720	22360B	22360BK	
320	440	90	3	14	8	1 670	2 820	154	840	1 080	*23964EMD1	*23964EMKD1	
	480	121	4	20	12	2 540	4 020	191	850	1 070	*23064EMD1	*23064EMKD1	
	480	160	4	20	12	3 250	5 400	184	720	920	*24064EMD1	*24064EMK30D1	
	540	176	5	27	16	4 020	6 020	227	700	880	*23164EMD1	*23164EMKD1	
	540	218	5	33	20	5 010	7 720	225	690	880	*24164EMD1	*24164EMK30D1	
	580	150	5	20	12	3 950	5 100	261	800	1 020	*22264EMD1	*22264EMKD1	
	580	208	5	33	20	5 230	7 370	259	640	820	*23264EMD1	*23264EMKD1	
340	460	90	3	14	8	1 710	2 980	162	800	1 020	*23968EMD1	*23968EMKD1	
	520	133	5	20	12	2 990	4 690	219	790	1 000	*23068EMD1	*23068EMKD1	
	520	180	5	27	16	3 910	6 510	206	670	860	*24068EMD1	*24068EMK30D1	
	580	190	5	27	16	4 670	6 870	257	650	830	*23168EMD1	*23168EMKD1	
	580	243	5	33	20	5 980	9 340	254	650	830	*24168EMD1	*24168EMK30D1	
	620	224	6	33	20	4 950	8 000	585	490	630	23268B	23268BK	
360	480	90	3	14	8	1 750	3 090	171	760	970	*23972EMD1	*23972EMKD1	
	540	134	5	20	12	3 070	4 910	232	750	950	*23072EMD1	*23072EMKD1	
	540	180	5	27	16	4 040	6 840	220	640	820	*24072EMD1	*24072EMK30D1	
	600	192	5	27	16	4 200	7 050	530	490	630	23172B	23172BK	
	600	243	5	33	20	5 100	9 150	470	490	630	24172B	24172BK30	
	650	232	6	33	20	5 400	8 700	620	450	590	23272B	23272BK	

1) Bearing numbers with * are ULTAGE series and have outer ring oil inlets and oil grooves as standard. Bearing models having outside diameter D dimension of 440 mm or more are the type EM (large size). 2) Bearings appended with "K" have a tapered bore ratio of 1:12; bearings appended with "K30" have a tapered bore ratio of 1:30. 3) Smallest allowable dimension for chamfer dimension r .

Installation-related dimensions					Constant e	Axial load factors			Mass (approx.) kg	
d_1	d_a Min.	mm D_a Max.	D_1	r_{as} Max.		Y_1	Y_2	Y_0	Cylindrical bore	Tapered bore
306	295	405	376	4	0.29	2.30	3.42	2.25	67.3	66.3
322	300	440	403	5	0.30	2.23	3.32	2.18	98.4	95.3
316	300	440	394	5	0.38	1.78	2.65	1.74	118	117
333	300	480	437	5	0.25	2.69	4.00	2.63	113	111
331	300	480	426	5	0.35	1.95	2.90	1.91	152	148
349	306	554	489	6	0.31	2.18	3.24	2.13	228	223
329	313	407	387	3	0.20	3.42	5.09	3.34	40.1	39.2
338	315	445	413	4	0.24	2.81	4.19	2.75	72.9	70.9
332	315	445	401	4	0.33	2.04	3.04	2.00	98.0	96.9
345	320	480	436	5	0.31	2.20	3.27	2.15	129	125
340	320	480	425	5	0.39	1.74	2.59	1.70	159	157
358	320	520	469	5	0.25	2.69	4.00	2.63	134	131
352	320	520	461	5	0.35	1.92	2.86	1.88	194	188
381	336	584	522	6	0.32	2.13	3.17	2.08	270	265
350	333	427	407	3	0.19	3.62	5.39	3.54	42.1	40.8
360	335	465	433	4	0.23	2.92	4.35	2.86	78.9	76.6
352	335	465	423	4	0.31	2.15	3.20	2.10	104	102
373	340	520	468	5	0.31	2.15	3.20	2.10	169	164
363	340	520	457	5	0.39	1.71	2.54	1.67	204	201
383	340	560	510	5	0.25	2.69	4.00	2.63	177	174
376	340	560	493	5	0.35	1.91	2.85	1.87	245	238
370	353	447	427	3	0.18	3.80	5.66	3.72	44.5	43.1
384	358	502	466	5	0.24	2.87	4.27	2.80	98.5	95.5
377	358	502	456	5	0.33	2.06	3.06	2.01	140	137
393	360	560	500	5	0.32	2.12	3.15	2.07	213	206
385	360	560	486	5	0.41	1.65	2.46	1.61	266	262
435	368	592	598	5	0.37	1.84	2.75	1.80	300	291
390	373	467	447	3	0.17	4.00	5.96	3.91	46.2	44.8
405	378	522	488	5	0.23	2.98	4.44	2.92	111	108
398	378	522	478	5	0.31	2.16	3.22	2.12	147	145
417	382	578	520	4	0.32	2.11	3.15	2.07	222	215
414	382	578	507	4	0.40	1.67	2.48	1.63	281	277
429	388	622	551	5	0.36	1.87	2.78	1.83	339	329

Note: Bearings other than the ULTAGE series with outside diameter D dimension of 320 mm or more are also provided with outer ring oil inlets and oil grooves.

Spherical Roller Bearings

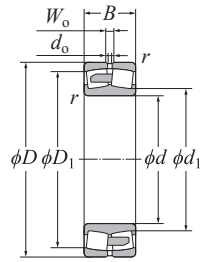

Cylindrical bore
[Type EM (large size)]

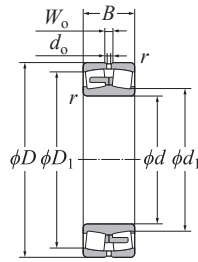

Cylindrical bore



Tapered bore

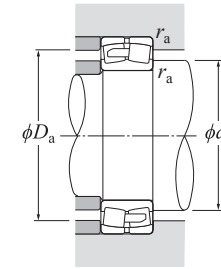

Dynamic equivalent radial load

$$P_r = XF_r + YF_a$$

$\frac{F_a}{F_r} \leq e$		$\frac{F_a}{F_r} > e$	
X	Y	X	Y
1	Y ₁	0.67	Y ₂

Static equivalent radial load

$$P_{0r} = F_r + Y_0 F_a$$

For values of e , Y_1 , Y_2
and Y_0 see the table below.

d 380–480 mm

d	Boundary dimensions					Basic load rating		Fatigue load limit kN C _u	Allowable speed		Bearing numbers ¹⁾		
	mm					dynamic kN	static		min ⁻¹	Grease lubrication	Oil lubrication	Cylindrical bore	Tapered bore ²⁾
	D	B	r _{s min} ³⁾	W _o	d _o	C _r	C _{0r}		910				
380	520	106	4	16	10	2 340	4 000	205	710	910	*23976EMD1	*23976EMKD1	
	560	135	5	20	12	3 230	5 270	247	720	910	*23076EMD1	*23076EMKD1	
	560	180	5	27	16	4 140	7 280	240	610	780	*24076EMD1	*24076EMK30D1	
	620	194	5	27	16	4 350	7 500	560	450	590	23176B	23176BK	
	620	243	5	33	20	5 350	9 650	570	450	590	24176B	24176BK30	
	680	240	6	33	20	5 800	9 650	665	430	550	23276B	23276BK	
400	540	106	4	16	10	2 370	4 170	215	680	870	*23980EMD1	*23980EMKD1	
	600	148	5	20	12	3 300	6 050	450	520	680	23080B	23080BK	
	600	200	5	27	16	4 250	8 400	485	460	600	24080B	24080BK30	
	650	200	6	27	16	4 650	8 050	630	430	560	23180B	23180BK	
	650	250	6	33	20	5 650	10 300	585	430	560	24180B	24180BK30	
	720	256	6	33	20	6 500	10 600	740	400	520	23280B	23280BK	
420	560	106	4	16	10	2 390	4 320	230	650	830	*23984EMD1	*23984EMKD1	
	620	150	5	20	12	3 450	6 400	475	490	640	23084B	23084BK	
	620	200	5	27	16	4 300	8 450	470	440	570	24084B	24084BK30	
	700	224	6	33	20	5 800	9 950	680	410	530	23184B	23184BK	
	700	280	6	33	20	6 850	12 200	755	410	530	24184B	24184BK30	
	760	272	7.5	33	20	7 300	12 000	820	380	490	23284B	23284BK	
440	600	118	4	16	10	2 260	4 700	325	500	650	23988	23988K	
	650	157	6	20	12	3 650	6 850	530	470	610	23088B	23088BK	
	650	212	6	33	20	4 800	9 450	530	420	540	24088B	24088BK30	
	720	226	6	33	20	5 800	10 100	685	390	500	23188B	23188BK	
	720	280	6	33	20	7 200	13 100	715	390	500	24188B	24188BK30	
	790	280	7.5	33	20	7 700	12 800	870	360	470	23288B	23288BK	
460	620	118	4	16	10	2 340	4 950	325	480	620	23992	23992K	
	680	163	6	27	16	4 000	7 450	560	450	580	23092B	23092BK	
	680	218	6	33	20	5 100	10 200	590	390	510	24092B	24092BK30	
	760	240	7.5	33	20	6 350	11 400	775	360	470	23192B	23192BK	
	760	300	7.5	33	20	7 900	14 500	805	360	470	24192B	24192BK30	
	830	296	7.5	33	20	8 650	14 500	925	340	440	23292B	23292BK	
480	650	128	5	20	12	2 590	5 500	365	450	590	23996	23996K	
	700	165	6	27	16	4 050	7 700	570	420	550	23096B	23096BK	
	700	218	6	33	20	5 200	10 500	610	380	490	24096B	24096BK30	

1) Bearing numbers with * are the ULTAGE series type EM (large size) and have outer ring oil inlets and oil grooves as standard.
2) Bearings appended with "K" have a tapered bore ratio of 1:12; bearings appended with "K30" have a tapered bore ratio of 1:30.
3) Smallest allowable dimension for chamfer dimension r.

Spherical Roller Bearings

Installation-related dimensions					Constant	Axial load factors			Mass (approx.)	
d ₁	d _a Min.	mm D _a Max.	D ₁	r _{as} Max.	e	Y ₁	Y ₂	Y ₀	Cylindrical bore	Tapered bore
412	395	505	481	4	0.18	3.66	5.46	3.58	68.0	65.9
425	398	542	509	5	0.22	3.07	4.57	3.00	117	113
420	398	542	499	5	0.30	2.25	3.34	2.20	154	151
436	402	598	540	4	0.31	2.16	3.22	2.12	235	228
431	402	598	529	4	0.39	1.73	2.58	1.69	292	287
453	408	652	575	5	0.36	1.89	2.82	1.85	380	369
433	415	525	501	4	0.18	3.80	5.66	3.72	71.4	69.2
451	422	578	542	4	0.24	2.80	4.16	2.73	149	144
446	422	578	528	4	0.32	2.09	3.11	2.04	202	200
458	428	622	567	5	0.31	2.21	3.28	2.16	264	256
453	428	622	552	5	0.38	1.77	2.63	1.73	329	324
473	428	692	612	5	0.37	1.81	2.69	1.77	457	443
454	435	545	522	4	0.17	3.95	5.88	3.86	74.9	72.6
471	442	598	562	4	0.24	2.85	4.24	2.79	157	152
465	442	598	551	4	0.32	2.13	3.18	2.08	210	207
488	448	672	611	5	0.32	2.11	3.15	2.07	354	343
477	448	672	592	5	0.40	1.69	2.51	1.65	440	433
501	456	724	643	6	0.36	1.86	2.77	1.82	544	528
483	458	582	551	3	0.18	3.66	5.46	3.58	101	98
490	468	622	585	5	0.24	2.85	4.24	2.79	181	175
486	468	622	576	5	0.32	2.11	3.15	2.07	245	241
504	468	692	627	5	0.31	2.15	3.21	2.11	370	358
498	468	692	614	5	0.39	1.75	2.61	1.71	456	449
525	476	754	671	6	0.36	1.88	2.80	1.84	600	582
503	478	602	572	3	0.17	3.95	5.88	3.86	107	104
512	488	652	613	5	0.23	2.88	4.29	2.82	206	200
509	488	652	604	5	0.31	2.15	3.21	2.11	276	272
534	496	724	660	6	0.31	2.14	3.19	2.10	443	429
523	496	724	645	6	0.39	1.71	2.55	1.67	550	541
547	496	794	703	6	0.36	1.87	2.78	1.83	704	683
527	502	628	599	4	0.18	3.85	5.73	3.76	123	119
532	508	672	633	5	0.23	2.94	4.38	2.88	217	209
530	508	672	625	5	0.30	2.22	3.30	2.17	285	280

Note: Outer ring oil inlets and oil grooves are provided.

● Spherical Roller Bearings

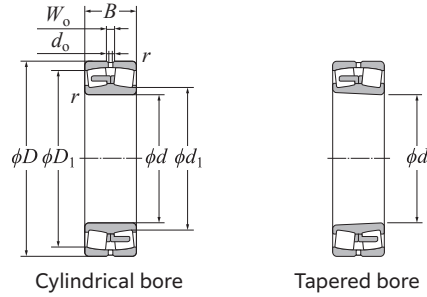

d 480–630 mm

d	Boundary dimensions					Basic load rating		Fatigue load limit kN C _u	Allowable speed		Bearing numbers	
	D	B	r _{s min} ²⁾	W _o	d _o	dynamic kN C _r	static kN C _{0r}		min ⁻¹ Grease lubrication	Oil lubrication	Cylindrical bore	Tapered bore ¹⁾
480	790	248	7.5	33	20	6 900	12 300	860	350	450	23196B	23196BK
	790	308	7.5	33	20	8 250	15 300	860	350	450	24196B	24196BK30
	870	310	7.5	33	20	9 200	15 500	1 000	320	420	23296B	23296BK
500	670	128	5	20	12	2 640	5 600	460	430	560	239/500	239/500K
	720	167	6	27	16	4 250	8 300	645	410	530	230/500B	230/500BK
	720	218	6	33	20	5 300	10 900	640	350	460	240/500B	240/500BK30
	830	264	7.5	33	20	7 700	13 700	875	330	430	231/500B	231/500BK
	830	325	7.5	42	25	9 000	16 700	870	330	430	241/500B	241/500BK30
	920	336	7.5	42	25	10 500	17 800	1 100	310	400	232/500B	232/500BK
530	710	136	5	20	12	2 940	6 450	400	400	520	239/530	239/530K
	780	185	6	27	16	4 850	9 350	710	380	490	230/530B	230/530BK
	780	250	6	33	20	6 200	12 700	700	330	430	240/530B	240/530BK30
	870	272	7.5	33	20	7 800	14 200	920	310	400	231/530B	231/530BK
	870	335	7.5	42	25	9 250	17 400	910	310	400	241/530B	241/530BK30
	980	355	9.5	42	25	11 500	19 800	1 210	280	370	232/530B	232/530BK
560	750	140	5	20	12	3 200	6 900	525	380	490	239/560	239/560K
	820	195	6	27	16	5 350	10 500	800	350	450	230/560B	230/560BK
	820	258	6	33	20	6 750	14 100	750	310	400	240/560B	240/560BK30
	920	280	7.5	33	20	8 550	15 500	1 000	280	370	231/560B	231/560BK
	920	355	7.5	42	25	11 100	20 800	1 030	280	370	241/560B	241/560BK30
	1 030	365	9.5	42	25	12 300	21 100	1 320	260	340	232/560B	232/560BK
600	800	150	5	20	12	3 600	8 000	490	350	450	239/600	239/600K
	870	200	6	27	16	5 800	12 000	835	310	420	230/600B	230/600BK
	870	272	6	33	20	7 150	15 600	750	280	370	240/600B	240/600BK30
	980	300	7.5	33	20	10 000	18 400	1 160	260	340	231/600B	231/600BK
	980	375	7.5	42	25	11 900	23 200	1 130	260	340	241/600B	241/600BK30
	1 090	388	9.5	42	25	13 600	23 700	930	250	320	232/600B	232/600BK
630	850	165	6	27	16	4 100	9 250	545	320	420	239/630	239/630K
	920	212	7.5	33	20	6 550	13 000	950	310	400	230/630B	230/630BK
	920	290	7.5	33	20	8 400	17 900	915	270	350	240/630B	240/630BK30
	1 030	315	7.5	33	20	10 700	19 900	1 190	250	320	231/630B	231/630BK
	1 030	400	7.5	42	25	12 900	25 000	1 200	250	320	241/630B	241/630BK30
	1 150	412	12	42	25	15 200	26 800	1 540	230	300	232/630B	232/630BK

1) Bearings appended with "K" have a tapered bore ratio of 1:12; bearings appended with "K30" have a tapered bore ratio of 1:30.
2) Smallest allowable dimension for chamfer dimension r.

● Spherical Roller Bearings

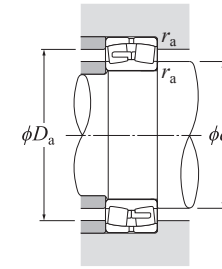

Dynamic equivalent radial load

$$P_r = X F_r + Y F_a$$

$\frac{F_a}{F_r} \leq e$		$\frac{F_a}{F_r} > e$	
X	Y	X	Y
1	Y ₁	0.67	Y ₂

Static equivalent radial load

$$P_{0r} = F_r + Y_0 F_a$$

For values of e, Y₁, Y₂ and Y₀ see the table below.

Installation-related dimensions				Constant	Axial load factors				Mass (approx.)	
d ₁	d _a Min.	D _a Max.	D ₁	r _{as} Max.	e	Y ₁	Y ₂	Y ₀	Cylindrical bore	Tapered bore
554	516	754	687	6	0.31	2.15	3.21	2.11	492	477
546	516	754	671	6	0.39	1.74	2.59	1.70	608	600
574	516	834	737	6	0.36	1.87	2.78	1.83	814	790
547	522	648	621	4	0.17	4.02	5.98	3.93	131	127
552	528	692	653	5	0.23	2.98	4.44	2.92	226	218
550	528	692	646	5	0.30	2.28	3.40	2.23	295	290
580	536	794	724	6	0.32	2.12	3.16	2.08	584	566
572	536	794	703	6	0.39	1.72	2.57	1.69	716	705
600	536	884	773	6	0.39	1.74	2.59	1.70	1 000	971
579	552	688	654	4	0.17	3.95	5.88	3.86	157	152
594	558	752	704	5	0.22	3.03	4.52	2.97	306	295
586	558	752	689	5	0.30	2.24	3.33	2.19	413	406
617	566	834	757	6	0.30	2.22	3.30	2.17	653	633
605	566	834	737	6	0.38	1.79	2.67	1.75	800	788
600	574	936	723	8	0.39	1.74	2.59	1.70	1 200	1 170
547	582	728	621	4	0.16	4.09	6.09	4.00	182	176
627	588	792	741	5	0.22	3.03	4.51	2.96	353	340
620	588	792	726	5	0.30	2.29	3.40	2.24	467	459
650	596	884	801	6	0.30	2.27	3.38	2.22	752	729
638	596	884	787	6	0.39	1.75	2.61	1.71	948	934
677	604	986	867	8	0.36	1.88	2.80	1.84	1 360	1 320
654	622	778	739	4	0.18	3.85	5.73	3.76	218	211
672	628	842	785	5	0.21	3.17	4.72	3.10	400	386
667	628	842	770	5	0.29	2.33	3.47	2.28	544	535
694	636	944	860	6	0.30	2.22	3.30	2.17	908	880
685	636	944	832	6	0.37	1.81	2.70	1.77	1 130	1 110
722	644	1 046	919	8	0.36	1.86	2.77	1.82	1 540	1 490
690	658	822	781	5	0.18	3.66	5.46	3.58	277	268
704	666	884	834	6	0.22	3.14	4.67	3.07	481	464
697	666	884	815	6	0.30	2.28	3.40	2.23	657	646
731	666	994	899	6	0.30	2.27	3.38	2.22	1 050	1 020
718	666	994	872	6	0.38	1.78	2.66	1.74	1 330	1 310
760	684	1 096	969	10	0.36	1.87	2.78	1.83	1 900	1 840

Note: Outer ring oil inlets and oil grooves are provided.

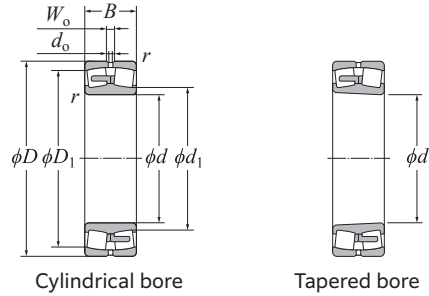

Cylindrical bore

Tapered bore

d 670–950 mm

d	Boundary dimensions					Basic load rating		Fatigue load limit kN C _u	Allowable speed		Bearing numbers	
	D	B	r _{s min} ²⁾	W _o	d _o	dynamic kN C _r	static kN C _{0r}		min ⁻¹ Grease lubrication	Oil lubrication	Cylindrical bore	Tapered bore ¹⁾
670	900	170	6	27	16	4 550	10 300	795	300	390	239/670	239/670K
	980	230	7.5	33	20	7 300	14 600	1 000	280	360	230/670B	230/670BK
	980	308	7.5	33	20	9 650	20 600	1 040	250	320	240/670B	240/670BK30
	1 090	336	7.5	42	25	12 500	23 600	1 400	230	300	231/670B	231/670BK
	1 090	412	7.5	42	25	14 100	28 000	1 340	230	300	241/670B	241/670BK30
	1 220	438	12	42	25	17 900	32 000	1 770	220	280	232/670B	232/670BK
710	950	180	6	27	16	4 950	11 500	665	280	370	239/710	239/710K
	1 030	236	7.5	33	20	8 000	16 200	1 140	260	340	230/710B	230/710BK
	1 030	315	7.5	33	20	10 300	22 500	1 150	230	300	240/710B	240/710BK30
	1 150	345	9.5	42	25	13 000	24 900	1 470	220	280	231/710B	231/710BK
	1 150	438	9.5	42	25	16 100	32 000	1 190	220	280	241/710B	241/710BK30
	1 280	450	12	42	25	18 100	32 500	1 200	200	260	232/710B	232/710BK
750	1 000	185	6	27	16	5 600	13 000	990	260	340	239/750	239/750K
	1 090	250	7.5	33	20	9 100	18 300	1 290	250	320	230/750B	230/750BK
	1 090	335	7.5	42	25	11 300	24 600	1 230	220	280	240/750B	240/750BK30
	1 220	365	9.5	42	25	14 300	27 200	1 130	200	260	231/750B	231/750BK
	1 360	475	15	42	25	20 300	36 500	1 980	180	240	232/750B	232/750BK
800	1 060	195	6	27	16	6 000	13 700	1 040	240	310	239/800	239/800K
	1 150	258	7.5	33	20	9 350	19 500	1 340	220	290	230/800B	230/800BK
	1 150	345	7.5	42	25	12 400	27 800	1 360	200	260	240/800B	240/800BK30
	1 280	375	9.5	42	25	16 000	31 000	1 780	180	240	231/800B	231/800BK
850	1 120	200	6	27	16	6 500	15 100	1 080	220	290	239/850	239/850K
	1 220	272	7.5	33	20	10 900	22 700	1 510	210	270	230/850B	230/850BK
	1 220	365	7.5	42	25	13 900	31 500	1 490	180	240	240/850B	240/850BK30
	1 360	400	12	42	25	17 300	34 000	1 380	170	220	231/850B	231/850BK
900	1 180	206	6	33	20	7 400	17 300	1 230	210	270	239/900	239/900K
	1 280	280	7.5	33	20	11 400	24 700	1 580	190	250	230/900B	230/900BK
	1 280	375	7.5	42	25	14 700	33 500	1 580	170	220	240/900B	240/900BK30
	1 420	412	12	42	25	18 700	38 000	2 030	150	200	231/900B	231/900BK
950	1 250	224	7.5	33	20	8 650	20 500	1 390	190	250	239/950	239/950K
	1 360	300	7.5	33	20	12 800	28 400	1 750	180	230	230/950B	230/950BK
	1 360	412	7.5	42	25	17 200	40 000	1 780	160	210	240/950B	240/950BK30

1) Bearings appended with "K" have a tapered bore ratio of 1:12; bearings appended with "K30" have a tapered bore ratio of 1:30.
2) Smallest allowable dimension for chamfer dimension r.

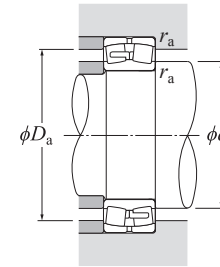

Dynamic equivalent radial load

$$P_r = X F_r + Y F_a$$

$\frac{F_a}{F_r} \leq e$		$\frac{F_a}{F_r} > e$	
X	Y	X	Y
1	Y ₁	0.67	Y ₂

Static equivalent radial load

$$P_{0r} = F_r + Y_0 F_a$$

For values of e, Y₁, Y₂ and Y₀ see the table below.

Installation-related dimensions				Constant	Axial load factors			Mass (approx.)		
d ₁	d _a Min.	D _a Max.	r _{as} Max.	e	Y ₁	Y ₂	Y ₀	Cylindrical bore	Tapered bore	
733	698	872	830	5	0.18	3.76	5.59	3.67	317	307
750	706	944	886	6	0.22	3.07	4.57	3.00	594	573
741	706	944	870	6	0.29	2.29	3.41	2.24	794	781
773	706	1 054	956	6	0.30	2.22	3.30	2.17	1 250	1 210
764	706	1 054	926	6	0.37	1.83	2.73	1.79	1 530	1 510
807	724	1 166	1 034	10	0.36	1.89	2.81	1.85	2 270	2 200
778	738	922	876	5	0.18	3.85	5.73	3.76	375	363
792	746	994	937	6	0.22	3.02	4.50	2.96	663	640
783	746	994	916	6	0.29	2.36	3.51	2.31	884	870
822	754	1 106	1 005	8	0.29	2.32	3.45	2.27	1 420	1 380
805	754	1 106	979	8	0.37	1.83	2.72	1.79	1 800	1 770
851	764	1 226	1 081	10	0.35	1.91	2.84	1.87	2 540	2 470
818	778	972	924	5	0.17	3.90	5.81	3.81	412	399
834	786	1 054	991	6	0.21	3.20	4.76	3.13	790	763
828	786	1 054	969	6	0.29	2.35	3.49	2.29	1 060	1 040
868	794	1 176	1 066	8	0.29	2.32	3.45	2.27	1 700	1 650
903	814	1 296	1 149	12	0.35	1.92	2.86	1.88	3 050	2 960
868	828	1 032	983	5	0.17	4.05	6.04	3.96	487	471
893	836	1 114	1 049	6	0.21	3.15	4.69	3.08	890	859
881	836	1 114	1 026	6	0.28	2.41	3.59	2.36	1 190	1 170
912	844	1 236	1 122	8	0.29	2.32	3.45	2.27	1 890	1 830
924	878	1 092	1 043	5	0.16	4.25	6.32	4.15	550	532
945	886	1 184	1 114	6	0.20	3.32	4.95	3.25	1 050	1 010
936	886	1 184	1 089	6	0.28	2.42	3.61	2.37	1 410	1 390
979	904	1 306	1 194	10	0.28	2.37	3.54	2.32	2 270	2 200
974	928	1 152	1 101	5	0.16	4.32	6.44	4.23	623	603
999	936	1 244	1 167	6	0.20	3.32	4.95	3.25	1 170	1 130
988	936	1 244	1 147	6	0.27	2.48	3.70	2.43	1 570	1 540
1 031	954	1 366	1 251	10	0.28	2.42	3.60	2.36	2 500	2 420
1 029	986	1 214	1 165	6	0.16	4.20	6.26	4.11	774	749
1 063	986	1 324	1 239	6	0.21	3.26	4.85	3.18	1 430	1 380
1 044	986	1 324	1 213	6	0.28	2.39	3.56	2.34	1 970	1 940

Note: Outer ring oil inlets and oil grooves are provided.

Spherical Roller Bearings

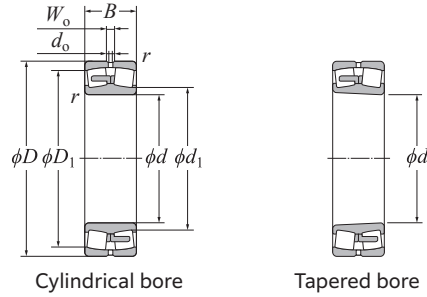

Cylindrical bore

Tapered bore

d 1 000–1 400 mm

Boundary dimensions	Basic load rating					Fatigue load limit	Allowable speed		Bearing numbers			
	mm						dynamic kN	static kN	min ⁻¹	Cylindrical bore	Tapered bore ¹⁾	
d	D	B	r _{s min} ²⁾	W _o	d _o	C _r	C _{0r}	Grease lubrication	Oil lubrication			
1 000	1 320	236	7.5	33	20	9 550	22 700	1 520	180	230	239/1000	239/1000K
	1 420	308	7.5	33	20	13 800	30 000	1 460	170	220	230/1000B	230/1000BK
	1 420	412	7.5	42	25	17 800	42 000	1 890	150	190	240/1000B	240/1000BK30
1 060	1 400	250	7.5	33	20	10 400	24 700	1 670	160	210	239/1060	239/1060K
	1 500	325	9.5	42	25	15 100	33 500	1 610	150	200	230/1060B	230/1060BK
	1 500	438	9.5	42	25	19 800	47 000	2 060	140	180	240/1060B	240/1060BK30
1 120	1 460	250	7.5	33	20	10 900	26 700	1 470	150	200	239/1120	239/1120K
	1 580	345	9.5	42	25	17 400	39 000	2 310	150	190	230/1120B	230/1120BK
	1 580	462	9.5	42	25	21 700	52 500	2 230	120	160	240/1120B	240/1120BK30
1 180	1 540	272	7.5	33	20	12 200	29 800	1 650	140	180	239/1180	239/1180K
1 250	1 630	280	7.5	33	20	13 400	33 500	1 810	120	160	239/1250	239/1250K
1 320	1 720	300	7.5	33	20	15 100	38 000	1 930	120	150	239/1320	239/1320K
1 400	1 820	315	9.5	33	20	16 800	43 000	2 570	100	130	239/1400	239/1400K

1) Bearings appended with "K" have a tapered bore ratio of 1:12; bearings appended with "K30" have a tapered bore ratio of 1:30.
2) Smallest allowable dimension for chamfer dimension r.

Spherical Roller Bearings

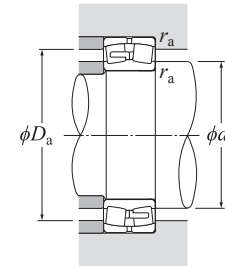

Dynamic equivalent radial load

$$P_r = XF_r + YF_a$$

$\frac{F_a}{F_r} \leq e$		$\frac{F_a}{F_r} > e$	
X	Y	X	Y
1	Y ₁	0.67	Y ₂

Static equivalent radial load

$$P_{0r} = F_r + Y_0 F_a$$

For values of e, Y₁, Y₂ and Y₀ see the table below.

Installation-related dimensions					Constant	Axial load factors			Mass (approx.)	
d ₁	d _a Min.	mm D _a Max.	D ₁	r _{as} Max.		e	Y ₁	Y ₂	Y ₀	Cylindrical bore kg
1 084	1 036	1 284	1 230	6	0.16	4.21	6.26	4.11	916	887
1 107	1 036	1 384	1 294	6	0.20	3.37	5.02	3.29	1 580	1 520
1 097	1 036	1 384	1 272	6	0.27	2.51	3.73	2.45	2 110	2 080
1 153	1 096	1 364	1 400	6	0.16	4.20	6.26	4.11	1 090	1 060
1 172	1 104	1 456	1 368	8	0.20	3.36	5.00	3.28	1 850	1 790
1 160	1 104	1 456	1 343	8	0.27	2.49	3.71	2.44	2 450	2 140
1 208	1 156	1 424	1 362	6	0.15	4.42	6.58	4.32	1 140	1 100
1 234	1 164	1 536	1 442	8	0.21	3.19	4.75	3.12	2 160	2 090
1 227	1 164	1 536	1 418	8	0.27	2.50	3.72	2.44	2 890	2 840
1 271	1 216	1 504	1 437	6	0.15	4.40	6.55	4.31	1 390	1 340
1 352	1 286	1 594	1 525	6	0.15	4.42	6.58	4.32	1 600	1 550
1 423	1 356	1 684	1 605	6	0.16	4.34	6.46	4.24	1 900	1 840
1 513	1 444	1 776	1 703	8	0.15	4.39	6.54	4.29	2 230	2 160

Note: Outer ring oil inlets and oil grooves are provided.

Adapters

(For spherical roller bearings)

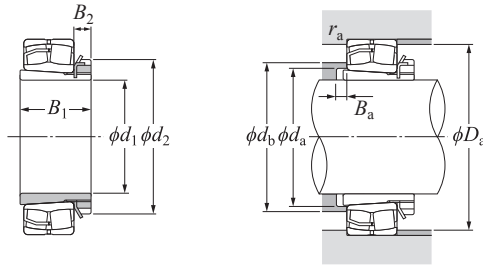

d₁ 25–70 mm

Boundary dimensions				Numbers ¹⁾		Installation-related dimensions						Mass ²⁾
mm				Bearing	Adapter	mm						kg
d ₁	B ₁	d ₂	B ₂			d _a Min.	d _b Max.	B _a Min.	Min.	D _a Max.	r _{as} Max.	(approx.)
25	31	45	8	*22206EAKW33	;H 306X	33	37	5	55	56	1	0.109
30	35	52	9	*22207EAKW33	;H 307X	38	45	5	63	65	1.1	0.142
35	36	58	10	*22208EAKD1	;H 308X	44	50	5	71	73	1.1	0.189
	36	58	10	21308CK	;H 308X	44	52	5	76	81.5	1.5	0.189
	46	58	10	*22308EAKD1	;H2308X	45	52	5	78	81	1.5	0.224
40	39	65	11	*22209EAKD1	;H 309X	49	54	8	76	78	1.1	0.248
	39	65	11	21309CK	;H 309X	49	57	5	85	91.5	1.5	0.248
	50	65	11	*22309EAKD1	;H2309X	50	58	5	87	91	1.5	0.280
45	42	70	12	*22210EAKD1	;H 310X	54	59	10	81	83	1.1	0.303
	42	70	12	21310CK	;H 310X	54	65	5	93	100	2	0.303
	55	70	12	*22310EAKD1	;H2310X	56	63	5	95	99	2	0.362
50	45	75	12	*22211EAKD1	;H 311X	60	66	11	90	91	1.5	0.345
	45	75	12	121311K	;H 311X	60	73	6	102	110	2	0.345
	59	75	12	*22311EAKD1	;H2311X	61	68	6	104	109	2	0.420
55	47	80	13	*22212EAKD1	;H 312X	65	71	9	99	101	1.5	0.394
	47	80	13	21312K	;H 312X	65	78	5	109	118	2	0.394
	62	80	13	*22312EAKD1	;H2312X	66	75	5	113	118	2.1	0.481
60	50	85	14	*22213EAKD1	;H 313X	70	78	8	107	111	1.5	0.458
	50	85	14	21313K	;H 313X	70	85	5	119	128	2	0.458
	65	85	14	*22313EAKD1	;H2313X	72	81	5	122	128	2.1	0.557
65	55	98	15	*22215EAKD1	;H 315X	80	88	12	118	121	1.5	0.831
	55	98	15	21315K	;H 315X	80	99	5	136	148	2	0.831
	73	98	15	*22315EAKD1	;H2315X	82	91	5	139	148	2.1	1.05
70	59	105	17	*22216EAKD1	;H 316X	86	94	12	127	129	2	1.03
	59	105	17	21316K	;H 316X	86	105	5	144	158	2	1.03
	78	105	17	*22316EAKD1	;H2316X	87	98	5	148	158	2.1	1.28

1) Bearing numbers marked "*" designate ULTAGE series. 2) Indicates the adapter mass.
 Note: 1. Refer to page B-218 through page B-221 for bearing dimensions, basic rated loads, and mass.
 2. Refer to page D-2 through page D-7 and page D-12 through page D-14 for adapter locknut and washer dimensions.
 3. Adapter numbers which are appended with the code "X" indicate narrow slit type adapters which use washers with straight inner tabs.

Adapters

(For spherical roller bearings)

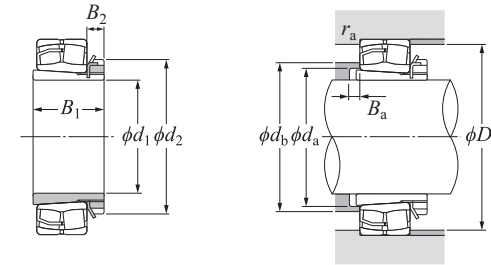

d₁ 75–115 mm

Boundary dimensions				Numbers ¹⁾		Installation-related dimensions						Mass ²⁾
mm				Bearing	Adapter	mm						kg
d ₁	B ₁	d ₂	B ₂			d _a Min.	d _b Max.	B _a Min.	Min.	D _a Max.	r _{as} Max.	(approx.)
75	63	110	18	*22217EAKD1	;H 317X	91	100	12	137	139	2	1.18
	63	110	18	21317K	;H 317X	91	111	6	152	166	2.5	1.18
	82	110	18	*22317EAKD1	;H2317X	94	107	6	157	166	3	1.45
80	65	120	18	*22218EAKD1	;H 318X	96	105	10	144	149	2	1.37
	86	120	18	*23218EMKD1	;H2318X	99	104	18	141	149	2	1.69
	65	120	18	21318K	;H 318X	96	119	6	162	176	2.5	1.37
	86	120	18	*22318EAKD1	;H2318X	99	110	6	166	176	3	1.69
85	68	125	19	*22219EAKD1	;H 319X	102	110	9	153	158	2.1	1.56
	68	125	19	21319K	;H 319X	102	127	7	171	186	2.5	1.56
	90	125	19	*22319EAKD1	;H2319X	105	120	7	174	186	3	1.92
90	71	130	20	*22220EAKD1	;H 320X	107	118	8	161	168	2.1	1.69
	97	130	20	*23220EMKD1	;H2320X	110	118	19	159	168	2.1	2.15
	71	130	20	21320K	;H 320X	107	133	7	179	201	2.5	1.69
	97	130	20	*22320EAKD1	;H2320X	110	127	7	187	201	3	2.15
100	81	145	21	*23122EAKD1	;H3122X	117	125	7	161	169	2	2.25
	77	145	21	*22222EAKD1	;H 322X	117	130	6	179	188	2.1	2.18
	105	145	21	*23222EMKD1	;H2322X	121	130	17	176	188	2.1	2.74
	77	145	21	21322K	;H 322X	117	146	9	203	226	2.5	2.18
	105	145	21	*22322EAKD1	;H2322X	121	139	7	209	226	3	2.74
110	72	145	22	*23024EAKD1	;H3024X	127	134	7	165	171	2	1.93
	88	155	22	*23124EAKD1	;H3124X	128	138	7	179	189	2	2.64
	88	155	22	*22224EAKD1	;H3124X	128	141	11	193	203	2.1	2.64
	112	155	22	*23224EMKD1	;H2324X	131	139	17	190	203	2.1	3.19
	112	155	22	*22324EAKD1	;H2324X	131	156	7	225	246	3	3.19
115	80	155	23	*23026EAKD1	;H3026	137	145	8	183	191	2	2.85
	92	165	23	*23126EAKD1	;H3126	138	148	8	189	199	2	3.66
	92	165	23	*22226EAKD1	;H3126	138	151	8	206	216	3	3.66
	121	165	23	*23226EMKD1	;H2326	142	150	21	203	216	3	4.6
	121	165	23	*22326EAKD1	;H2326	142	164	8	243	263	4	4.6

1) Bearing numbers marked "*" designate ULTAGE series. 2) Indicates the adapter mass.
 Note: 1. Refer to page B-220 through page B-225 for bearing dimensions, basic rated loads, and mass.
 2. Refer to page D-2 through page D-7 and page D-12 through page D-14 for adapter locknut and washer dimensions.
 3. Adapter numbers which are appended with the code "X" indicate narrow slit type adapters which use washers with straight inner tabs.

Adapters

(For spherical roller bearings)

NTN

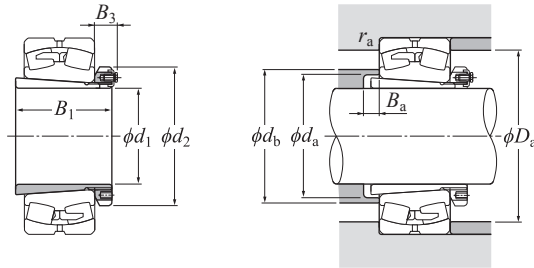

d_1 300–470 mm

d_1	Boundary dimensions			Numbers ¹⁾	Installation-related dimensions						Mass ²⁾
	mm				Bearing		Adapter		mm		
	B_1	d_2	B_3		d_a	d_b	B_a	D_a	r_{as}	(approx.)	
	Min.	Max.	Min.	Max.	Min.	Max.	Min.	Max.	Max.		
300	258	400	56	*23264EMKD1 ;H3264	343	376	13	493	560	5	39.3
	187	400	58	*23068EMKD1 ;H3068	355	384	14	466	502	5	28.7
320	254	440	72	*23168EMKD1 ;H3168	360	393	14	500	560	5	49.5
	288	440	72	23268BK ;H3268	364	410	14	524	592	5	54.6
340	188	420	58	*23072EMKD1 ;H3072	375	405	14	488	522	5	30.5
	259	460	75	23172BK ;H3172	380	417	14	520	578	4	54.2
	299	460	75	23272BK ;H3272	385	429	14	551	622	5	60.2
360	193	450	62	*23076EMKD1 ;H3076	396	425	15	509	542	5	35.8
	264	490	77	23176BK ;H3176	401	436	15	540	598	4	61.7
	310	490	77	23276BK ;H3276	405	453	15	575	652	5	69.6
380	210	470	66	23080BK ;H3080	417	451	15	542	578	4	41.3
	272	520	82	23180BK ;H3180	421	458	15	568	622	5	70.6
	328	520	82	23280BK ;H3280	427	473	15	612	692	5	81
400	212	490	66	23084BK ;H3084	437	471	16	562	598	4	43.7
	304	540	90	23184BK ;H3184	443	488	16	611	672	5	84.2
410	228	520	77	23088BK ;H3088	458	490	17	585	622	5	65.2
	307	560	90	23188BK ;H3188	464	504	17	627	692	5	104
430	234	540	77	23092BK ;H3092	478	512	17	613	652	5	69.5
	326	580	95	23192BK ;H3192	485	534	17	660	724	6	116
450	237	560	77	23096BK ;H3096	499	532	18	633	672	5	73.3
	335	620	95	23196BK ;H3196	505	554	18	687	754	6	133
470	247	580	85	230/500BK ;H30/500	519	552	18	653	692	5	81.8
	356	630	100	231/500BK ;H31/500	527	580	18	724	794	6	143

1) Bearing numbers marked "*" designate ULTAGE series. 2) Indicates the adapter mass.

Note: 1. Refer to page B-230 through page B-235 for bearing dimensions, basic rated loads, and mass.

2. Refer to page D-2 through page D-7 and page D-12 through page D-15 for adapter locknut and locking clip dimensions.

Withdrawal Sleeves

(For spherical roller bearings)

NTN

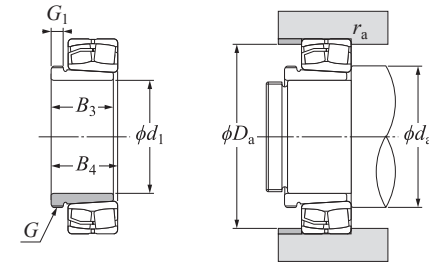

d_1 35–70 mm

d_1	Boundary dimensions				Numbers ³⁾	Installation-related dimensions					Mass ⁴⁾	Applied nut number ⁵⁾
	mm					Bearing		Withdrawal sleeve		mm		
	Thread nominal dimension ¹⁾	G	B_3	G_1 B_4 ²⁾		Withdrawal sleeve	d_a	D_a	r_{as}	(approx.)		
						Min.	Max.	Min.	Max.	Max.		
35	M45×1.5	29	6	32	*22208EAKD1 ;AH 308	47	50	71	73	1.1	0.09	AN09
	M45×1.5	29	6	32	21308CK ;AH 308	48.5	52	76	81.5	1.5	0.09	AN09
	M45×1.5	40	7	43	*22308EAKD1 ;AH 2308	49	52	78	81	1.5	0.128	AN09
40	M50×1.5	31	6	34	*22209EAKD1 ;AH 309	52	54	76	78	1.1	0.109	AN10
	M50×1.5	31	6	34	21309CK ;AH 309	53.5	57	85	91.5	1.5	0.109	AN10
	M50×1.5	44	7	47	*22309EAKD1 ;AH 2309	54	58	87	91	1.5	0.164	AN10
45	M55×2	35	7	38	*22210EAKD1 ;AHX 310	57	59	81	83	1.1	0.137	AN11
	M55×2	35	7	38	21310CK ;AHX 310	60	65	93	100	2	0.137	AN11
	M55×2	50	9	53	*22310EAKD1 ;AHX2310	61	63	95	99	2	0.209	AN11
50	M60×2	37	7	40	*22211EAKD1 ;AHX 311	64	66	90	91	1.5	0.161	AN12
	M60×2	37	7	40	21311K ;AHX 311	65	73	102	110	2	0.161	AN12
	M60×2	54	10	57	*22311EAKD1 ;AHX2311	66	68	104	109	2	0.253	AN12
55	M65×2	40	8	43	*22212EAKD1 ;AHX 312	69	71	99	101	1.5	0.189	AN13
	M65×2	40	8	43	21312K ;AHX 312	72	78	109	118	2.1	0.189	AN13
	M65×2	58	11	61	*22312EAKD1 ;AHX2312	72	75	113	118	2.1	0.297	AN13
60	M75×2	42	8	45	*22213EAKD1 ;AH 313	74	78	107	111	1.5	0.253	AN15
	M75×2	42	8	45	21313K ;AH 313	77	85	119	128	2.1	0.253	AN15
	M75×2	61	12	64	*22313EAKD1 ;AH 2313	77	81	122	128	2.1	0.395	AN15
65	M80×2	43	8	47	*22214EAKD1 ;AH 314	79	84	113	116	1.5	0.28	AN16
	M80×2	43	8	47	21314K ;AH 314	82	91	126	138	2.1	0.28	AN16
	M80×2	64	12	68	*22314EAKD1 ;AHX2314	82	85	131	138	2.1	0.466	AN16
70	M85×2	45	8	49	*22215EAKD1 ;AH 315	84	88	118	121	1.5	0.313	AN17
	M85×2	45	8	49	21315K ;AH 315	87	99	136	148	2.1	0.313	AN17
	M85×2	68	12	72	*22315EAKD1 ;AHX2315	87	91	139	148	2.1	0.534	AN17

1) Standard thread shapes and dimensions are as per JIS B 0205-1 and JIS B 0205-4 (general metric thread).

2) Indicates reference dimensions before withdrawal sleeves are attached.

3) Bearing numbers marked "*" designate ULTAGE series.

4) Indicates withdrawal sleeve mass.

5) Indicates the number of nuts to be used at the time of disassembly. Refer to page D-2 through page D-10 for nut dimensions.

Note: Refer to page B-218 through page B-221 for bearing dimensions, basic rated loads, and mass.

Withdrawal Sleeves

(For spherical roller bearings)

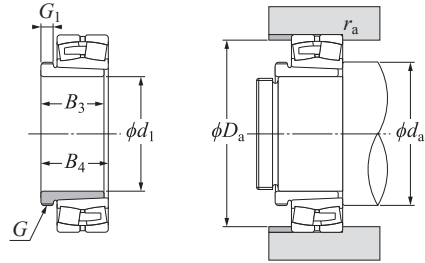

d₁ 260–360 mm

d ₁	Boundary dimensions mm			Numbers ³⁾⁴⁾	Installation-related dimensions mm					Mass ⁵⁾ kg	Applied nut number ⁶⁾	
	Thread nominal dimension ¹⁾	G	B ₃		G ₁	B ₄ ²⁾	Bearing	Withdrawal sleeve	Min. d _a			Max. d _a
260	Tr300×4	202	22	219	*24156EMK30D1;AH24156H	300	316	394	440	5	16.3	HN60
	Tr310×5	155	24	163	*22256EMKD1;AH 2256	300	333	437	480	5	15.2	HN62
	Tr310×5	212	30	220	*23256EMKD1;AH 2356	300	331	426	480	5	21.6	HN62
	Tr310×5	212	30	220	*22356EMKD1;AH 2356	306	349	489	554	6	21.6	HN62
280	Tr320×5	145	26	153	*23060EMKD1;AH 3060	315	338	413	445	4	14.4	HNL64
	Tr310×5	184	24	202	*24060EMK30D1;AH24060H	315	332	401	445	4	15.5	HN62
	Tr330×5	192	30	200	*23160EMKD1;AH 3160	320	345	436	480	5	20.8	HN66
	Tr320×5	224	24	242	*24160EMK30D1;AH24160H	320	340	425	480	5	19.5	HN64
	Tr330×5	170	26	178	*22260EMKD1;AH 2260	320	358	469	520	5	18.1	HN66
	Tr330×5	228	34	236	*23260EMKD1;AH 3260	320	352	461	520	5	26	HN66
300	Tr345×5	149	27	157	*23064EMKD1;AH 3064	335	360	433	465	4	16	HNL69
	Tr340×5	184	24	202	*24064EMK30D1;AH24064H	335	352	423	465	4	16.6	HN68
	Tr350×5	209	31	217	*23164EMKD1;AH 3164	340	373	468	520	5	24.5	HN70
	Tr340×5	242	24	260	*24164EMK30D1;AH24164H	340	363	457	520	5	21.4	HN68
	Tr350×5	180	27	190	*22264EMKD1;AH 2264	340	383	510	560	5	20.2	HN70
	Tr350×5	246	36	254	*23264EMKD1;AH 3264	340	376	493	560	5	30.6	HN70
320	Tr365×5	162	28	171	*23068EMKD1;AH 3068	358	384	466	502	5	19.5	HNL73
	Tr360×5	206	26	225	*24068EMK30D1;AH24068H	358	377	456	502	5	21.7	HNL72
	Tr370×5	225	33	234	*23168EMKD1;AH 3168	360	393	500	560	5	29	HN74
	Tr360×5	269	26	288	*24168EMK30D1;AH24168H	360	385	486	560	5	27.1	HNL72
340	Tr385×5	167	30	176	*23072EMKD1;AH 3072	378	405	488	522	5	21	HNL77
	Tr380×5	206	26	226	*24072EMK30D1;AH24072H	378	398	478	522	5	22.7	HNL76
	Tr400×5	229	35	238	23172BK;AH 3172	382	417	520	578	5	33	HN80
	Tr380×5	269	26	289	24172BK30;AH24172H	382	414	507	578	5	29.6	HNL76
360	Tr410×5	170	31	180	*23076EMKD1;AH 3076	398	425	509	542	5	23.2	HNL82
	Tr400×5	208	28	228	*24076EMK30D1;AH24076H	398	420	499	542	5	23.7	HNL80
	Tr420×5	232	36	242	23176BK;AH 3176	402	436	540	598	5	35.7	HN84
	Tr400×5	271	28	291	24176BK30;AH24176H	402	431	529	598	5	31.3	HNL80

1) Standard thread shapes and dimensions are as per JIS B 0216 (metric trapezoidal screw thread).
 2) Indicates reference dimensions before withdrawal sleeves are attached.
 3) Bearing numbers marked "*" designate ULTAGE series.
 4) Withdrawal sleeve numbers appended with the suffix "H" signify the high pressure oil (hydraulic) design.
 5) Indicates withdrawal sleeve mass.
 6) Indicates the number of nuts to be used at the time of disassembly. Refer to page D-2 through page D-10 for nut dimensions.
 Note: Refer to page B-230 through page B-233 for bearing dimensions, basic rated loads, and mass.

Withdrawal Sleeves

(For spherical roller bearings)

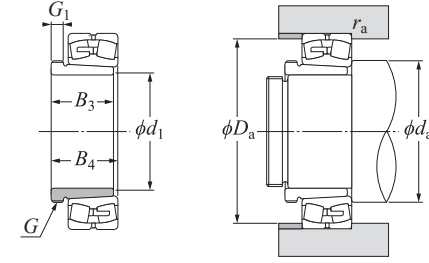

d₁ 380–460 mm

d ₁	Boundary dimensions mm			Numbers ³⁾	Installation-related dimensions mm					Mass ⁴⁾ kg	Applied nut number ⁵⁾	
	Thread nominal dimension ¹⁾	G	B ₃		G ₁	B ₄ ²⁾	Bearing	Withdrawal sleeve	Min. d _a			Max. d _a
380	Tr430×5	183	33	193	23080BK;AH 3080	422	451	542	578	5	27.3	HNL86
	Tr420×5	228	28	248	24080BK30;AH24080H	422	446	528	578	5	27.1	HNL84
	Tr440×5	240	38	250	23180BK;AH 3180	428	458	568	622	6	39.5	HN88
	Tr420×5	278	28	298	24180BK30;AH24180H	428	452	552	622	6	34.4	HNL84
400	Tr450×5	186	34	196	23084BK;AH 3084	442	471	562	598	5	29	HNL90
	Tr440×5	230	30	252	24084BK30;AH24084H	442	465	551	598	5	29	HNL88
	Tr460×5	266	40	276	23184BK;AH 3184	448	488	611	672	6	46.5	HN92
	Tr440×5	310	30	332	24184BK30;AH24184H	448	477	592	672	6	40.3	HNL88
420	Tr470×5	194	35	205	23088BK;AHX3088	468	490	585	622	6	32	HNL94
	Tr460×5	242	30	264	24088BK30;AH24088H	468	485	576	622	6	31.9	HNL92
	Tr480×5	270	42	281	23188BK;AHX3188	468	504	627	692	6	49.8	HN96
440	Tr460×5	310	30	332	24188BK30;AH24188H	468	498	614	692	6	42.3	HN92
	Tr490×5	202	37	213	23092BK;AHX3092	488	512	613	652	6	35.2	HNL98
460	Tr510×6	285	43	296	23192BK;AHX3192	496	534	660	724	7.5	57.9	HN102
	Tr480×5	332	32	355	24192BK30;AH24192H	496	523	645	724	7.5	47.4	HNL96
460	Tr520×6	205	38	217	23096BK;AHX3096	508	532	633	672	6	39.2	HNL104
	Tr530×6	295	45	307	23196BK;AHX3196	516	554	687	754	7.5	63.1	HN106

1) Standard thread shapes and dimensions are as per JIS B 0216 (metric trapezoidal screw thread).
 2) Indicates reference dimensions before withdrawal sleeves are attached.
 3) Withdrawal sleeve numbers appended with the suffix "H" signify the high pressure oil (hydraulic) design.
 4) Indicates withdrawal sleeve mass.
 5) Indicates the number of nuts to be used at the time of disassembly. Refer to page D-2 through page D-10 for nut dimensions.
 Note: Refer to page B-232 through page B-235 for bearing dimensions, basic rated loads, and mass.