



Instruction Manual

(With Warranty Card)

Small Sized Frequency Variable Controller High Power Type (Both for AC200V) K-ECK96 (Control capacity 12A)

Before use
Read this Instruction Manual to the last and operate the machine correctly.

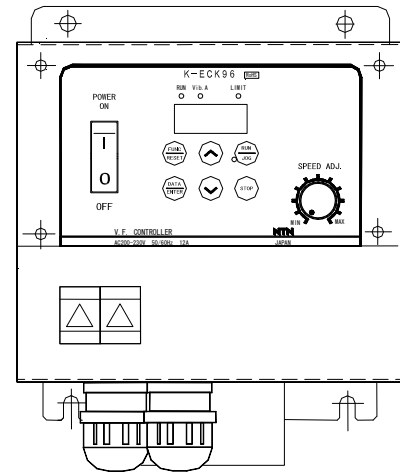

Introduction

Thank you for your purchase of NTN small sized frequency controller (high power type). In order to correctly and safely operate this controller, please read this instruction manual before using this device without fail. This instruction manual with warranty card shall be delivered to end users without fail. In addition, user shall keep this manual at the safe place where readily available whenever needed even after reading.

1. Before usage

In order for you to use this device correctly and safely and to make the most of its function, notes below and on the next page shall be observed.

- On receiving this device, please check if there is any failure due to the transportation. If you find any inconvenience such as a failure, do not hesitate to contact the nearest sales office.
- This controller is only for NTN electromagnetic parts feeder. Usage in other than this application or usage exceeding the specification range is prohibited. It may cause failures.
- The "parts feeder" described in this instruction manual is the generic names for the bowl feeder, the linear feeder and so on.









Contents







Page

Introduction	1
1. Before Usage	1
2. Notes on Safety	2 to 4
3. Function and Features	5
4. Appearance & Names of Portions	6
5. Installation	7
6. For the first time use	8 to 9
7. Connection of Input/Output (Block diagram)	10 to 22 11
8. Driving and Adjustment	23 to 33
9. Setting of Functions (F - V Curve)	34 to 46 47
10. Protection/Warning Function	48 to 49
11. Troubleshooting	50 to 52
12. Specification (Outside Dimensions) (Replacement method of fuses)	53 to 54 54 54

2. Notes on Safety

As to the safety, users must have a great responsibility of their own. Be sure to begin any operation after reading through this operation manual. In addition, in order to use this controller with safe, be sure to obey the warning and caution labels of this device as well as to observe the following notes.

 Danger	<p>This description shows that not observing this remark and mishandling the device will cause the death or serious injury of human body with high probability.</p>
 Warning	<p>This description shows that not observing this remark and mishandling the device will cause the death or serious injury of human body.</p>
 Caution	<p>This description shows that not observing this remark and mishandling the device may cause an injury of human body or property damage.</p>
 Danger	
	<p>Please never work until the LED display of the operation panel turns. Please begin the work after two minutes or more pass after power supply OFF. There is fear of an electric shock.</p>
	<p>Please never drive with the panel opened (an emergency case is excluded). Moreover, please turn off the power supply when you open the panel. It gets an electric shock, short-circuited, and is likely to ignite.</p>
	<p>Please never do the wiring work without cutting off the primary side power supply or the main breaker. It gets an electric shock, short-circuited, and is likely to ignite.</p>
	<p>This controller is a controller only for the NTN parts feeder (electromagnetic type vibration part supply machine). It is not possible to use it for other usages such as a piezo-electric type parts feeders and the single phase motors. It gets short-circuited and is likely to ignite.</p>
 Warning	
	<p>Please ground the earth cables of the controller and the main body without fail. There is a fear of an electric shock if you do not ground it.</p>
	<p>Please never use it in the place with a gas or a liquid that explodes and ignites. It causes a fire.</p>
	<p>Please a person other than the repair engineer never performs disassembling, repairing nor remodeling this device. It may ignite or do abnormal motion to make him/her injured.</p>

 <h2 style="display: inline;">Warning</h2>	
	<p>It must not be used in a place where it exposes to water, oil or chemicals, or outdoors, or in a place of high temperature and humidity. There is a fear of an electric shock, a fire or a failure.</p>
	<p>Please do not scratch, pull or forcibly bend the wiring. Moreover, when a heavy thing is put on the wiring, or it is pinched, the wiring will be damaged. It causes a fire or an electric shock.</p>
	<p>Please do not touch controller's output terminal during energizing the controller while even stopping. <u>There is a fear of an electric shock because the alternating current of maximum 200V is applied to the output terminal.</u></p>
	<p>Please do not connect AC power to the output terminal (1 and 2). It causes a fire or the breakdown.</p>
	<p>Foreign objects such as paper, waste wood or oil must not be allowed to enter the controller, and the controller must not ruin its heat radiation by covering it with such as the cloth. There is a fear of the burn or a fire, etc.</p>
	<p>Please do not operate the switch by a wet hand. There is a fear of an electric shock.</p>
	<p>Please do not use it with other than the specified voltage. It causes a fire or the breakdown.</p>
	<p>Please turn off the power supply or the main breaker on the primary side when you replace fuses. There is a fear of an electric shock.</p>
 <h2 style="display: inline;">Caution</h2>	
	<p>The sheet metal of the controller BOX might become high temperature (50-70°C). Please note that there is a fear of the burn. Moreover, please install a space for heat radiation in the surroundings. (Refer to P.7)</p>
	<p>Please do not do "ON" and "OFF" of the power supply <u>frequently</u>. The controller will break down. (Please refer to the paragraph 7.-(5) the wiring of external control input in P.16)</p>
	<p>Please do not repeat "ON" and "OFF" of the power supply in a short time. A big inrush current flows and there is a possibility that the controller breaks down.</p>
	<p>Please do not install it in the place where the vibration or the impact is acting. The controller breaks down.</p>



Caution



Please refer to the note of caution on the margin below when doing the dielectric breakdown test and megger test (measurement of the insulation resistance by the megohmmeter).

The controller breaks down when making a mistake.

Please do not do an operation such as switching of the displayed data or setting of the function etc. after power supply OFF (during the period from power supply OFF to LED turning off).

When the subsequent power supply is turned on, it is likely to stop with Er2.



There is a distinction between the ground phase and non-ground phase in the power supply. Please confirm the earth phase side of the power supply, and connect controller's specified terminal to the earth phase side. (Refer to P.12).

There is a possibility of causing a fire when the wiring is grounded.

Please install the leak breaker or the leak detector on the primary side of power supply of the controller for the ground fault protection. Especially, please install it surely when it is not possible to connect it to the ground phase.

There is a possibility of causing a fire when the wiring is grounded.

Surely connect the earth clip of the welding machine to the bowl when welding to the bowl. An incorrect connection of the earth for the welding may burn the earth cable that connects the main body and the controller, and fears such as electric shock, leaks, and the burn of the controller exist.

Please don't conduct the welding work without turning off the power supply or the main breaker on the primary side of the controller. There is a possibility of causing damage of the controller.

Please select and use an appropriate cable according to the voltage used, the current, and the environment.

There is a fear of a leak or a fire when a wrong cable is used.

It doesn't stop immediately even if the power is cut off. Moreover, the run/stop key is effective only when the function is set. Therefore, when you urgently stop the machine when the driving is controlled from the outside, please stop it by using the external control signal.

Please set the F/V curve and the current rating before driving the main body.

When making a mistake in the setting, the magnet might be damaged by firing.

Please be sure that wiring for vibration sensor, that is an option part, is free from noise. If noise gets in, it may be malfunctioning or vibration amplitude may become large suddenly.

Take care of pulling the wiring around and cables used etc. (Refer to P.14~15)

Be sure not to install or drive a damaged controller or a controller which is lack in parts.

There is a fear of an injury.

The noise is generated from the controller or wiring and equipments connected to the controller. Please take care that neither a peripheral equipment nor the sensor will malfunction. There is a fear of an accident.

*Note: Please execute the dielectric breakdown test with AC1500V or less between AC line and the earth, and DC500V or less between DC line and the earth. The leakage of current shall be 10mA or less. Moreover, during the test, the high pressure is charged in the internal capacitor. Be careful enough so as not to get an electric shock.

Terms appearing frequently in this Instruction Manual

1. "Parts feeder" means generic names of such as bowl feeders and linear feeders, and for NTN products only.
2. The one only written as main body indicates "Vibration main body of parts feeder".
3. The one only written as LED indicates the data display portion on the operation side (Refer to P.6).
4. Original NTN terms such as "air blow during driving" is used. Please inquire of NTN for details of the operation.

3. Function and Features

(1) High precision digital control with micro processor

As various settings and operations are controlled digitally, highly precise and highly stabilized control is achieved. At the same time, as a set value is displayed digitally, resetting of values is easy.

(2) Wide input "responding to wide voltage of power supply"

Range of input power supply is wide input of AC200~230V \pm 10% (50/60Hz \pm 10%).

(3) Overload protection (Refer to P.36, Function J01 in P.38)

When the current rating of load connected is set, the output voltage is automatically controlled not to exceed this current value. While this function is operating, LED turns to alternative display of the output voltage and the OL to call attention. In case that it is not fixed even if the output voltage is lowered to 20V or less, driving is stopped and emergency signal (continued lighting of OL) comes out. This function is applicable for case that the set value of current rating is 2.0A and more. Setting is possible even under less than 2.0A but it is inaccurate.

(4) Multi-speed function (Refer to P.20, function H12~20 of P.43~44 and P.46)

Three kinds of speed data can be memorized internally, and the speed can be changed by the switch signal from the outside.

(5) Enhancement of the protection function

At time of output short-circuit or ground fault*¹, overload and power supply voltage drop*², driving is stopped and controller, peripheral equipment and circuit device are protected.

*1 Ground fault in this controller means short circuit with the earth at the output side. Please note that protection against ground fault or electric leak in the internal circuit is not possible

*2 When the power supply voltage dropped, LV is displayed and driving is stopped, but when the power supply voltage returns, controller also returns automatically. Please note that when driving conditions are put into place, driving starts.

(6) Panel lock (Refer to P.45)

The operation from the operation panel can be prohibited if necessary. A wrong operation by an operator or unintended change of setting by his/her contact etc. can be excluded. Two kinds of locks, the operation lock and the knob lock, are installed according to the restricted range.

(7) Output terminal for air blow (Refer to P.19)

Since control circuit of solenoid valve for air blow is included as standard equipment, air blow control during driving can be used easily.

(8) Work shortage detection function (Refer to P.21, Function H08 to H10 in P.42 to 43)

The work shortage detection timer is installed.

4. Appearance and Names of Portions

(1) Appearance diagram (Refer to P.7 and P.54 for dimensions)

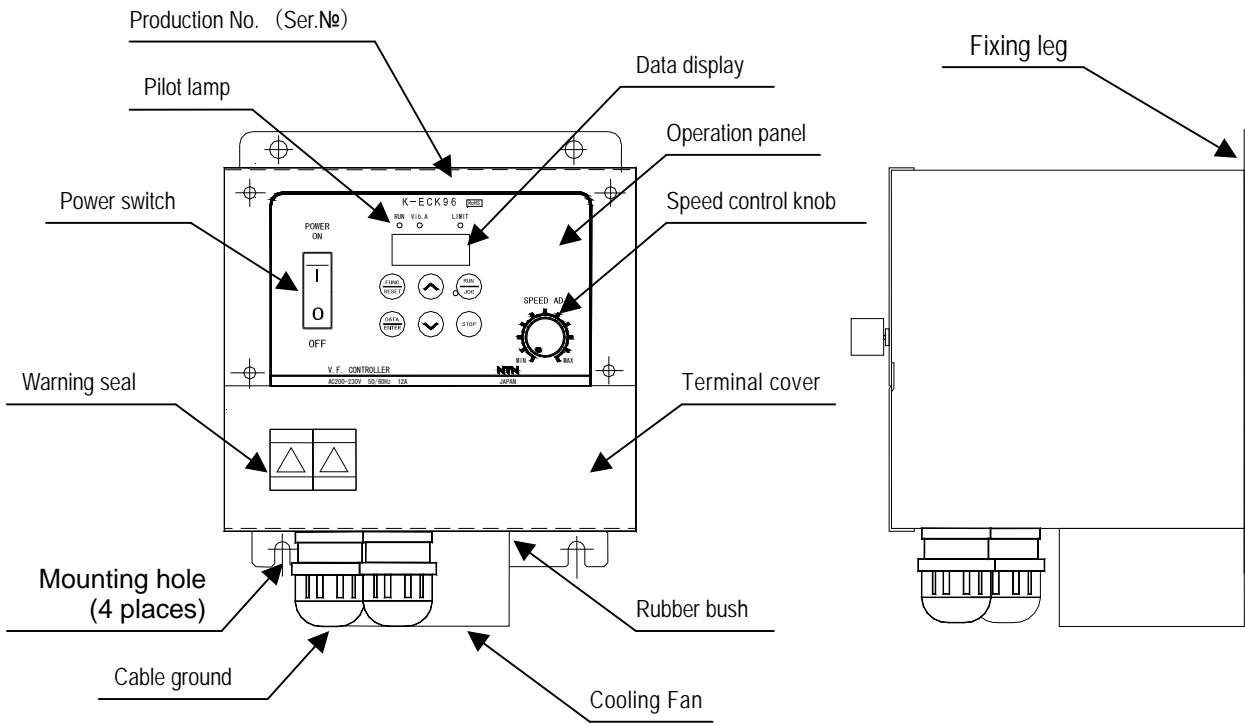

(2) Terminal board (View with terminal cover removed)

Terminal board layout (Magnified diagram)

Terminal names are printed on the board

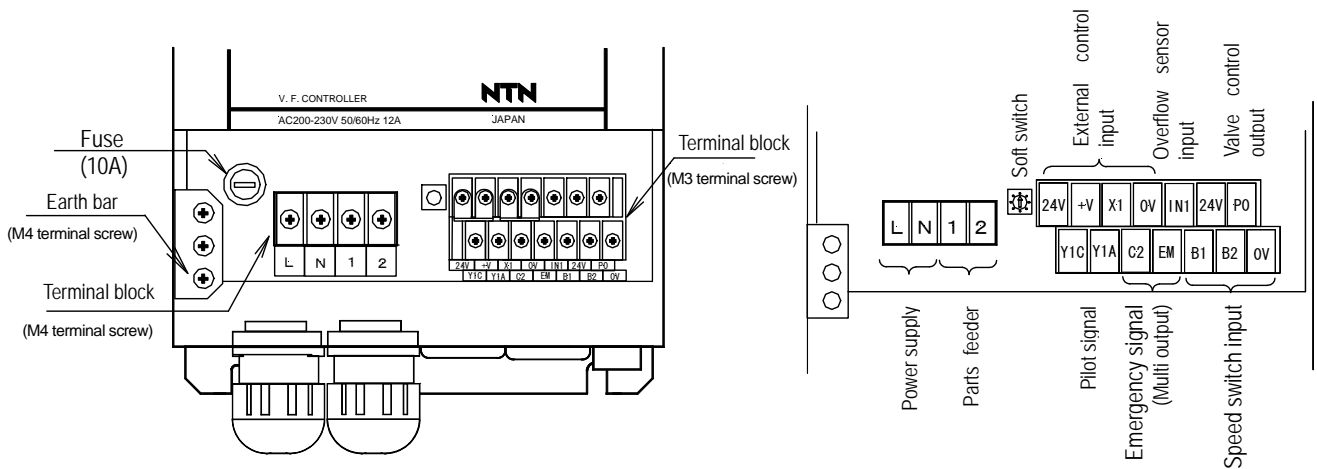

5. Installation

(1) Installation place

- ① Please install it on a firm material such as metals (nonflammable material) having no vibration.
- ② Please have a space in surroundings without fail so as not to ruin heat radiation and install it vertically.
- ③ Oils and fats and chemicals, etc. may hurt the resin, painting, and the cable of BOX. These liquid and mist must not splash directly on the controller.

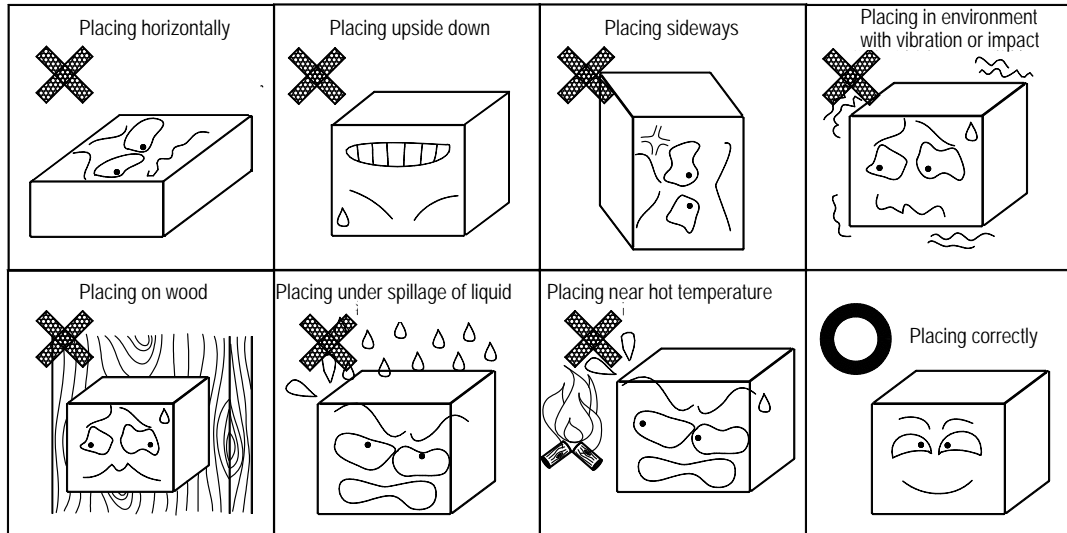

(2) Installation hole and surrounding space

Please refer to the figure below for the dimension concerning controller's installation. Moreover, it is necessary to leave a space shown in the figure below in the surroundings of the controller for heat radiation (Unit: mm)

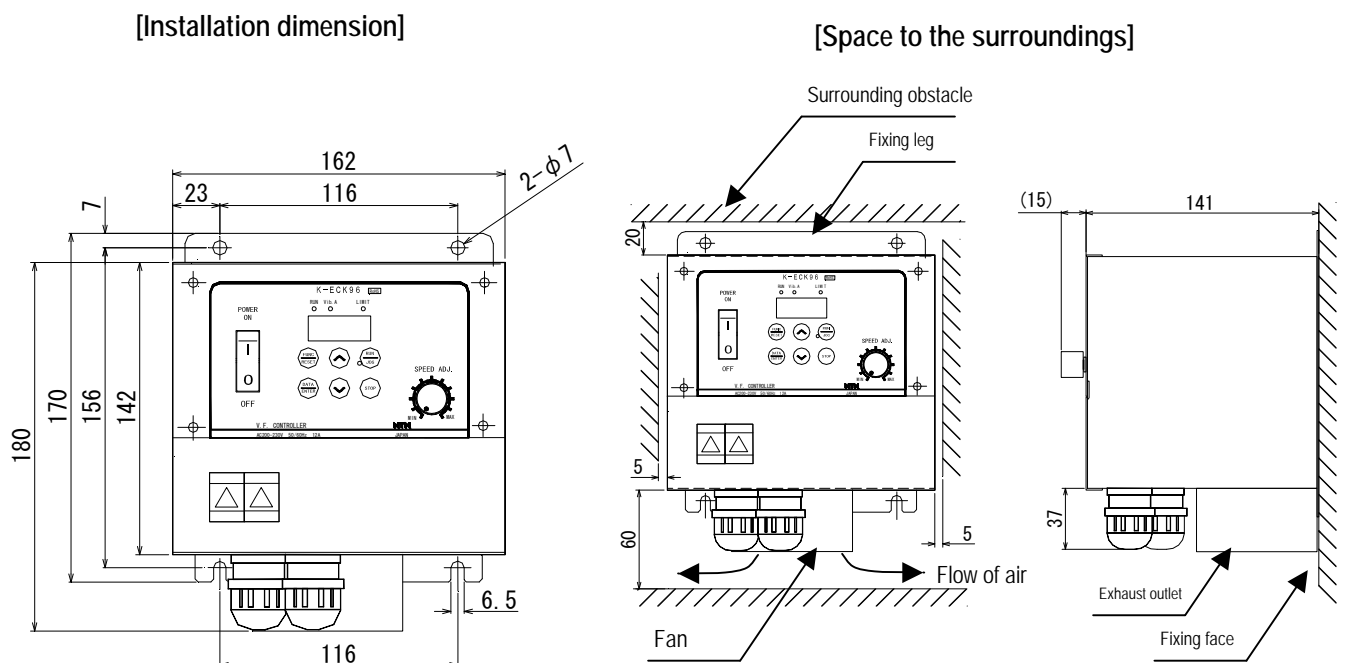

- ※ It is cooled with fan. Be sure not to house it in small closed container or enclose around with obstacles blocking air flow. Please mount in such a manner that operating face side, side face and bottom face are left open. (Port of cooling air is at the bottom face side.)

6. For the first time use

When you use the controller first time after the purchase, please make connections of input-output and set all kinds of functions according to the following chart. In case that you purchased it as a completed product, such as setting is not necessary. But please check connections and settings without fail before driving. (Refer to designated pages for the details.)

For driving under constant voltage mode (Refer to the next page for driving under constant amplitude mode.)

Flow for driving (Constant voltage mode)

1. Connection of input-output

Connect the parts feeder used and input-output signal cable etc.

Refer to P.10 onward

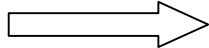

< Basic connection >

- Connection of power source → P.12
- Connection of load cable (parts feeder) → P.13

< Connection based on using conditions >

- External control input → P.16 ~ P.17
- Connection of sensor or valve etc. → P.18 ~ P.19

2. Setting of functions

Functions are set to match your using conditions.

Refer to P.34 onward

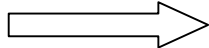

< Setting of function (J group) >

- Setting of current rating J01
- Setting of driving method J02
- Setting of F-V curve J04 etc.

< Setting of data (H group) >

- Sensor input logic H00
- Sensor timer H01, H02 etc.

3. Driving

Driving signal is input to start driving.

Refer to P.25

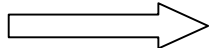

In case that driving signal was input by your company, start driving.

4. Frequency adjustment

Frequency is adjusted so that the amplitude of parts feeder is appropriate.

Refer to P.26

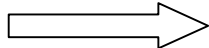

Driving frequency is adjusted manually to appropriate range.

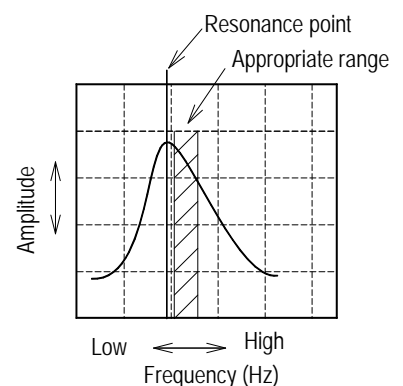

5. Speed (Voltage) adjustment

Voltage is adjusted with the speed adjustment knob so that appropriate amplitude is output.

Refer to P.31

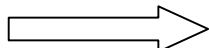

Amplitude (Voltage) increases by turning the speed adjustment knob clockwise.

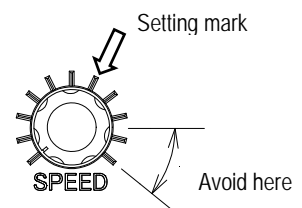

For driving under constant amplitude mode (Please purchase vibration sensor separately, that is an option part.)

Flow for driving (Constant amplitude mode)

1. Connection of input-output
Connect the parts feeder used and input-output signal cable etc.

Refer to P.10 onward
→

< Basic connection >

- Connection of power source→P.12
- Connection of load cable (parts feeder)→P.13

< Connection based on using conditions >

- External control input→P.16~P.17
- Connection of sensor or valve etc.→P.18~P.19

2. Connection of vibration sensor
Please purchase vibration sensor separately.

Refer to P.14 onward
→

< Installation of vibration sensor >

- Installation of vibration sensor on parts feeder→P.14

< Wiring of vibration sensor >

- Connection of connector to controller→P.15

3. Setting of functions
Functions are set to match your using conditions.

Refer to P.34 onward
→

< Setting of function (J group) >

- Setting of current rating J01 etc.

< Setting of data (H group) >

- Sensor input logic H00 etc.

4. Driving
Driving signal is input to start driving.

Refer to P.25
→

In case that driving signal was input by your company, start driving.

5. Frequency adjustment
Frequency is adjusted so that the amplitude of parts feeder is appropriate.

Refer to P.26
→

Driving frequency is adjusted manually to appropriate range.

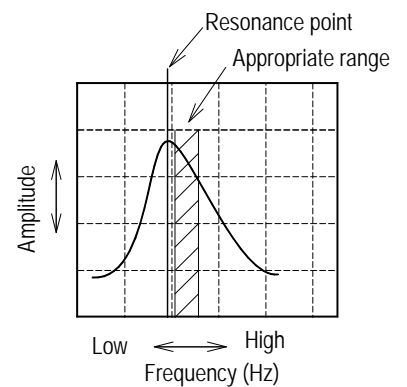

6. Calibration
Implementation of calibration

Refer to P.28
→

Calibration is conducted with the function key J05 to determine gain.

5. Speed (Voltage) adjustment
Voltage is adjusted with the speed adjustment knob so that appropriate amplitude is output.

Refer to P.31
→

Amplitude (Voltage) increases by turning the speed adjustment knob clockwise.

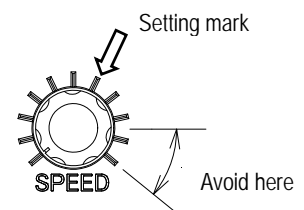

7. Connection of Input-Output

External connection diagram (Also refer to the block diagram in the next page)

(Details of each wiring are described in the page shown in the notes written below, therefore please refer to them)

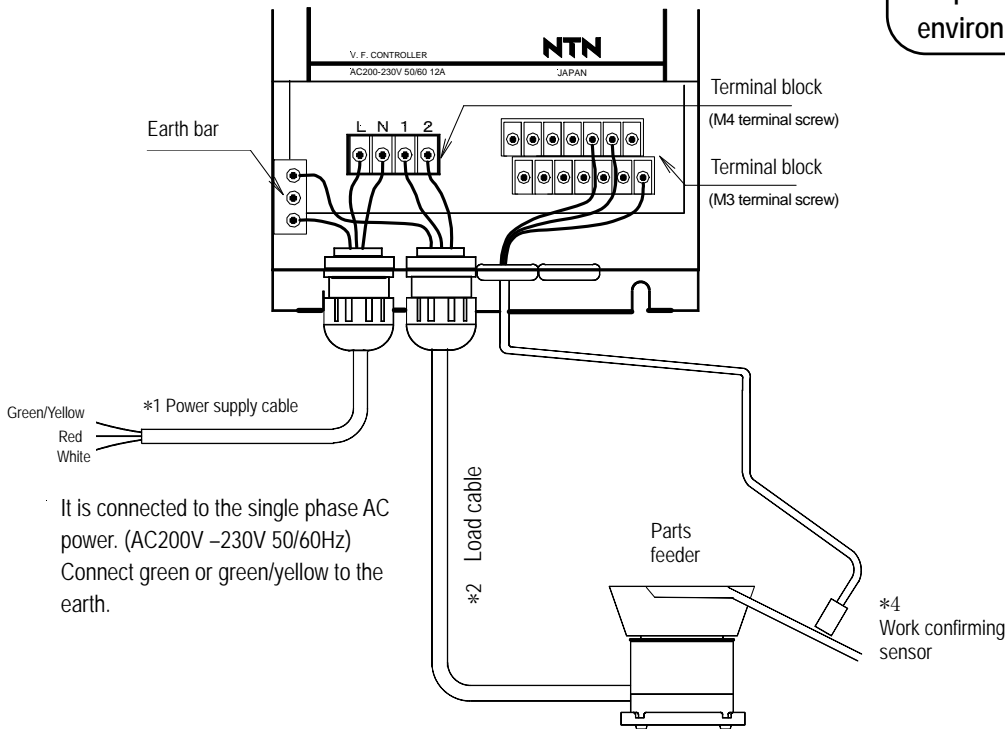

It is connected to the single phase AC power. (AC200V –230V 50/60Hz)
Connect green or green/yellow to the earth.

⚠ Danger

Do the wiring work after cutting off the main breaker without fail. It is likely to get an electric shock.

⚠ Caution

Please select an appropriate type to the kind and the size of the cable used and responding to use conditions and the environment.

【Layout of terminal board for control】

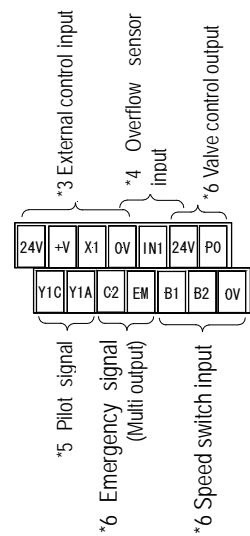

Caution

Please refer to the descriptions in caution for safety in P.2 to 4 and explanations for each item below for the wiring method and cautions when wiring.

*1 Wiring of power supply	P.12	Refer to paragraph "Connection to power supply"
*2 Wiring of load	P.13	Refer to paragraph "Connection to load line"
*3 Wiring of external control input	P.16 to 17	Refer to paragraph "Wiring of external control input"
*4 Wiring of overflow sensor	P.18 to 19	Refer to paragraph "Connection of sensor"
*5 Receiving of drive signal	P.21	Refer to paragraph "Wiring of drive instruction output"
*6 Others		
Multi-speed control	P.20	Refer to paragraph "Multi-speed function"
Valve wiring	P.19	Refer to paragraph "Air blow control during driving"
Emergency signal	P.21	Refer to paragraph "Wiring of emergency signal"

*7 There is a possibility that the noise is added in the power supply line. Please take measures such as separation of the power supply from equipments which dislike noise or insertion of noise filter.

*8 Cable length

Main circuit (L,N,1,2)・・・For extension, the size must be 2.5 mm² or more and the length must be 10m or less. Signal line・・・The length must be within 10m and the line must be separated from the power cable.

*9 After wiring work is completed, check the safety by protective continuity test.

Controller block diagram (Refer to the previous page for wiring)

Controller K-ECK96

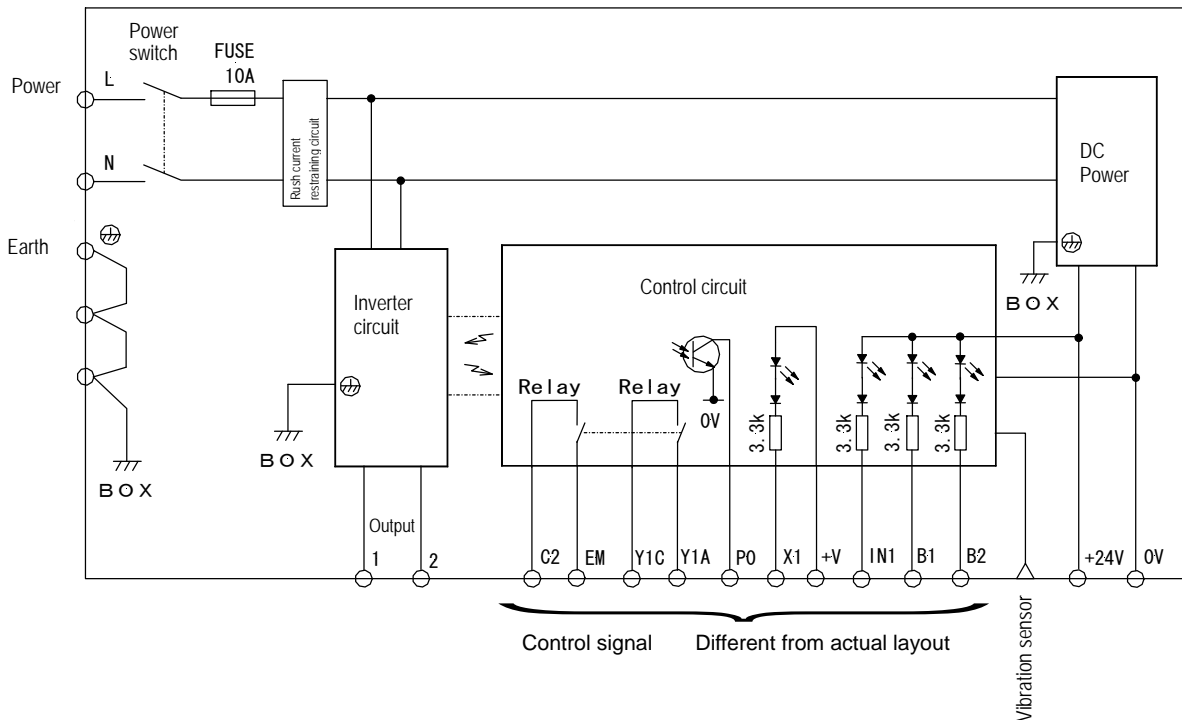

- *1 The array of the terminal in the above figure is different in sequence order from the actual terminal array.
- *2 0V of the input circuit and 24V of the input/output circuit are all common.
- *3 All circuit constitutions for input circuit of IN1, B1 and B2 and output circuit of P0 are basically same circuit constitution.
- *4 Vibration sensor is an option part.

(1) Open the terminal cover

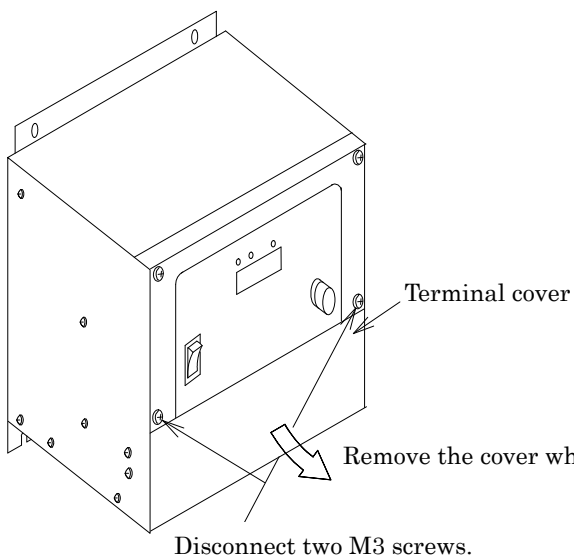

⚠ Danger

Do the wiring work after cutting off the main breaker without fail.

- ① Disconnect two M3 screws fixing the terminal cover. The screws are not designed to prevent slipping off. Be fully careful not to lose them.
- ② Pull the bottom side of the terminal cover toward this side while moving the cover downward. The terminal cover will come off.

(2) Connection to power supply

For details of the terminal board layout, please refer to P.6 and P.10.

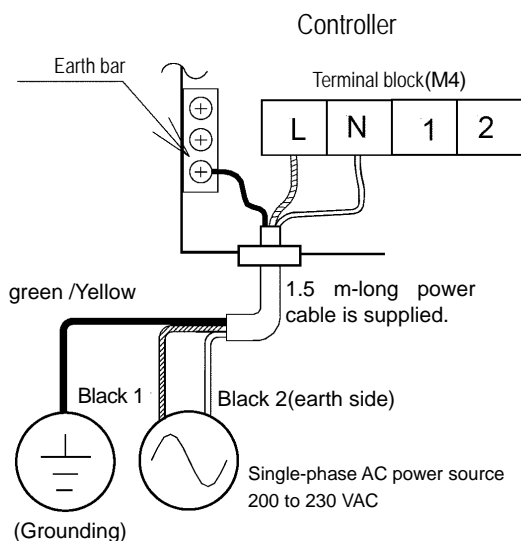

Warning
 Connect the earth cable without fail. There is a fear of electric shock if the earth is not connected.

The power supply cable is connected to the single phase power supply. At this time, please connect the terminal N (color of the lead: white or black 2) to the earth phase side for protection against the earth fault without fail.

Name of terminal board	Color of lead	Remarks	
L	Red or Black 1	Non-earth side	} Single phase power
N	White or Black 2	Earth side	
Earth bar	Green of Green/Yellow	Earth	

- Note 1. The controller for the parts feeder must be connected to the power supply of the commercial power or the sine wave voltage output. Please do not connect it to the output side of the inverter that contains the harmonic component such as sine wave PWM inverters. The controller breaks down.
- Note 2. For protection of ground fault accident of controller, be sure to connect N terminal to the grounding phase side without fail. When the grounding phase side is unknown, please install the electric leak detecting device or the electric leak breaker. Refer to the clause of specification of P.53 for current rating.
- Note 3. Power supply cable length shall be 10m or less. Moreover, please use the cable of the size of 2.5mm² or more when extending it to 3m or more (The protection coordination with the primary side breaker is noted). Replacement work of power supply cable shall be made by engineers with enough knowledge about controller. Additionally, the connection to the controller terminal board must be done by using the round type crimping terminal (The terminal screw: M4).
- Note 4. Please refer to "Notes for transformer usage" in the bottom column in the next page when you use the transformer.
- Note 5. Correct earth shall be checked by a protection continuity tester after the earth construction work ends. When the earth is imperfect, it is likely to get an electric shock.
- Note 6. There is a possibility that the noise is added in the power supply line. Please take measures such as separation of the power supply from equipments which dislike noise or insertion of noise filter. Moreover, please do not put the main circuit (power supply or load line) and the signal line in the same duct (protection tube).
- Note 7 It is possible to connect it to the three phase power supply. In this case, please use two phases (for example, R and S phases) out of three phases (R, S and T) for the power supply. In addition, please wire after confirming the phase grounded by a voltage detector etc. so that the terminal on N side is the earth phase. Please wire through a leak breaker when the earth phase is unknown.

(3) Connection of load line

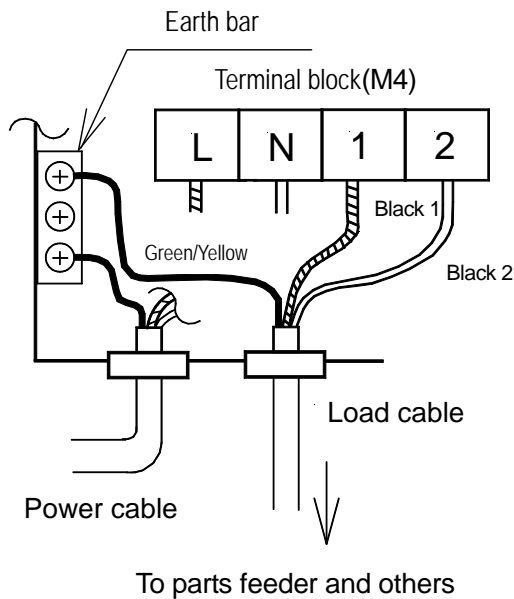

Please connect the load line (load cable of the parts feeder attachment) to the terminal board through controller's cable ground. As the voltage of max AC200V applies to this terminal, be careful of the wiring enough. Please refer to the following note 1 when extending the line.

Name of terminal board	Color of wiring
1	Black 1 or Red
2	Black 2 or White
Earth bar	Green/Yellow, Green or Black

- *1 Please do not connect this to other than the parts feeder. It breaks down.
- *2 Please refer to P.17 when connecting the hopper separately placed as wiring of level switch is necessary.
- *3 The connection to the controller terminal board must be done by using the round type crimping terminal (The terminal screw: M4).

Note 1 Extension of cable length

Please use the size of 2.0mm² or more when you change the cable. Moreover, when extending it to 3m or more, please connect it to the main body cable by extending it to the vicinity of the main body by using the cable of the size of 2.5mm² or more, and using the relay BOX. Extension length shall be 10m or less.

Note 2 There is a possibility that the noise is added in the load cable. When the load cable is close to equipments which dislike noise, please take measures such as separation of wiring route from them and the use of shield cable. Moreover, do not put the load cable and the signal line into the same duct (protection tube).

Note 3 Correct earth shall be checked by protection continuity test machine after the earth construction work ends. When the earth is imperfect, it is likely to get an electric shock.

* Notes for transformer usage

Please note not only the current rating but also the voltage descent due to the inrush current, etc. when you supply power to the controller through the transformer. Please note enough the voltage descent at power supply ON and the trouble due to the noise especially when the transformer is set commonly with other equipments. Please consult the transformer maker about details of the problem when supplying the power to the controller (inverter). Please refer to the paragraph of the input in P.53 for controller's inrush current. Moreover, to reduce the influence by the noise, the use of the shielded wire or wiring of a distance as short as possible is recommended.

(4) Wiring of vibration sensor

Vibration sensor is an option part. Please purchase separately.

① Installation of vibration sensor

Install the vibration sensor on the upper part of vibration main body or to vibrating part of such as a bowl, referring to the figure below. Please prepare processing of tapping holes (M3 tapping at two places, 10mm pitch) on the installation section and installation screws in your company. Moreover, please install at the position where the impact is not easily transmitted to the vibration sensor when work falls off on the bowl or the chute.

② Installation direction of vibration sensor

Vibration direction of vibration sensor is predetermined. Install it so that it vibrates in the direction of arrow mark printed on the sensor. If it is made to vibrate in the orthogonal direction to arrow mark, the sensitivity is poor and it is not possible to be used. Moreover, for this controller, replace the arrow mark ⇒ of vibrating direction by ⇄.

※For such as G type bowl feeder, it is recommended to install to the upper vibrating body. As the cover exists, it is also useful to protect the vibration sensor.

Note) If the impact at the time of work fall-off transmits to the vibration sensor, there is a possibility of the controller's malfunction (the output voltage downs). Please don not install it in the vicinity of the work transfer routes.

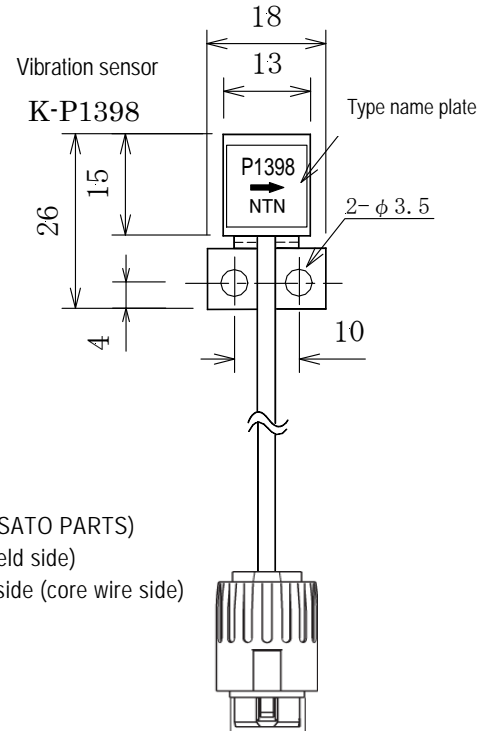

Connector
 CN-70-3P-P(SATO PARTS)
 1Pin: 0V (shield side)
 2Pin: Signal side (core wire side)
 3Pin: Open

⚠ Caution

If the vibration sensor contacts to other objects while vibrating, there is a possibility of the malfunction. Please note enough the installation and the handling.

Parts feeder

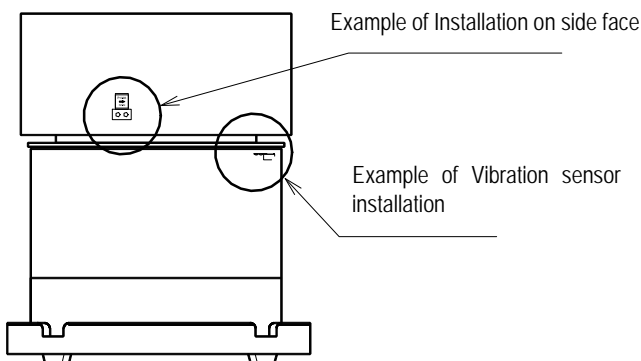

③Wiring of vibration sensor

It is recommended that the lead of vibration sensor is fixed nearby the fixing screws for the vibration sensor using a nylon saddle etc. Unless it is fixed, there is a possibility that vibration of the lead is picked up as noise. Please pull the lead around separately from the load cable of the parts feeder. If they are wired in parallel, noise might be picked up. Moreover, the lead uses the shield cable. As the external coat of shield cable is weak against the external force, it is recommended to protect it with a external tube etc.

When the installation of the vibration sensor is completed, please plug the connector of the vibration sensor into the controller.

Notes for extension of lead

Please use an exclusive extension cable (K-P1400: 3m long), which is available as an option. It is possible to make it max.11m by connecting those three cables in series. Please contact NTN for the detail.

The vibration sensor K-P1398 can be extended even using a normal cabtire cable. However, an extreme care is required for noise. Moreover, please make the extension length within 5m in total.

Please extend the middle portion by cutting off the lead of vibration sensor and using the cabtire cable and using the terminal board. However, please wire separately from the load cable of the parts feeder, other power cable, cable of high frequency equipment or equipment outputting harmonic noise.

Note) When any symptom as below came out at the adjustment after extending using the cabtire cable, please change to the extension using the shield cable.

- Calibration can not be done well.
- Output voltage does not increase even turning the speed adjustment knob clockwise.
- Limit lamp remains lighting even vibrating little.

Notes for extension using shield cable

Please use a one core shield cable or a coaxial cable for the shield cable and connect the shield side also to the connector of the controller without fail. Do not connect to other OV or the earth.

Even in case that the shield cable is used, the length of extension should be 10m or less. However, as there is a possibility that noise is transmitted depending on the environment even within 10m, please try to make it shorter if possible. (Reference: Recommended cable 1.5D-2V [Coaxial cable])

Then, installation and wiring of the vibration sensor are completed. By the connection of the vibration sensor, the constant amplitude control becomes possible. But, in order to use these functions, adjustment of functions etc. is needed furthermore. Please use referring to the driving/adjustment method in P. 23 and after.



Caution

Please take care of noise when the vibration sensor lead (length: 2m), is extended. Length of extension should be within total 5m for the normal cable, and within total 10m for the shield cable. However, the length extended is not a guaranteed value. There may be a case that extension is not possible depending on the environment.

(5) Wiring of external control input

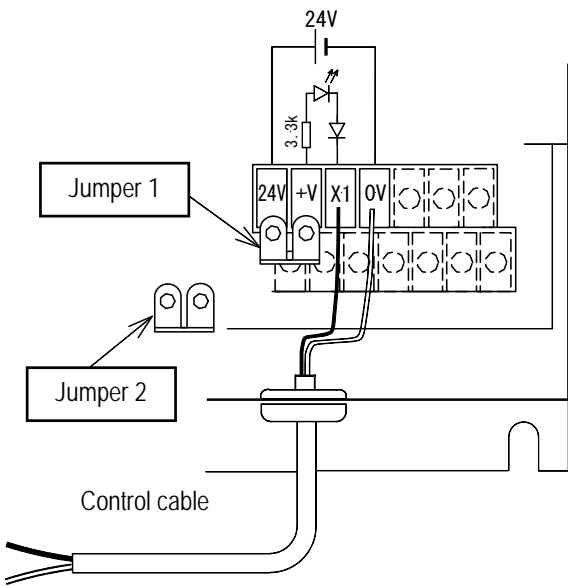

⚠ Caution

24V, X1 and 0V terminals have polarity. Please be careful of wiring enough. In addition, please never connect it to AC power.

⚠ Caution

Parts feeder's ON/OFF control must use the external control input terminal. ON/OFF control by the power supply is impossible.

Wiring method to control parts feeder's ON/OFF from outside when the function is a standard setting, is explained.

- ① Check that between 24V-+V terminals is short-circuited with jumper. In case jumper or control wire etc. is not in, short-circuit them
- ② The jumper wire between terminals of X1 and 0V is removed, and the relay contact (or NPN transistor) is connected between these terminals. Do not remove jumper 1.

※ When the ON/OFF delay timer is intended to be used, use the IN input. Please prepare cables used for control by your company.

When function №. JO2 is set as 1 (standard).

- With short-circuited state between X1 — 0V, parts feeder is driven (for NPN transistor output, it is Lo level)
- With open state between X1 — 0V, parts feeder is stopped (for NPN transistor output, it is High level)

When the logic is reversed (JO2 is set as 0) by the function, it is driven with open state. Please refer to P.39 for the setting of the function JO2.

Please refer to the next page when controlling by the PNP transistor output or using it for the hopper control.

Note 1 The current of DC24V 7mA flows between terminals X1-0V. Please be careful of the noise enough because it is a minute electric current.

Note 2 The cable length of signal input line (24V, +V, X1, 0V) should be within 10m. Adopt a twist wiring if it is possible.

In case of no external control used

When the external control terminal is not used, make function JO2 setting as "1" and have the external control input terminal short-circuited (at two positions of 24V-+V and X1-0V). The controller drives continuously. Even if the setting of JO2 is made "0" and the external control input terminal is opened, it becomes a continuous driving.

***1 Wiring method when controlling with PNP transistor output**

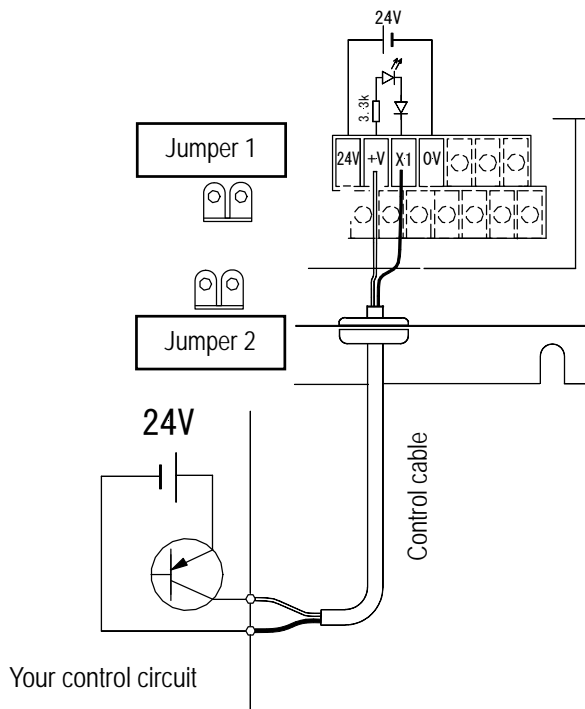

When controlling by the PNP transistor, please connect the output (collector) side of the PNP transistor to +V terminal, and the terminal X1 to the common line (0V) side of the controlling equipment. The current of about 7mA flows under the control with 24V because internal resistance of 3.3kΩ is connected.

Your 24V power supply is used in case of the PNP control.

It is possible to control similarly even by the relay contact instead of the transistor.

The selection of the logic of the driving or the stop at the short-circuit can be selected by the function J02.

***2 Wiring method when connecting to the separately placed hopper**

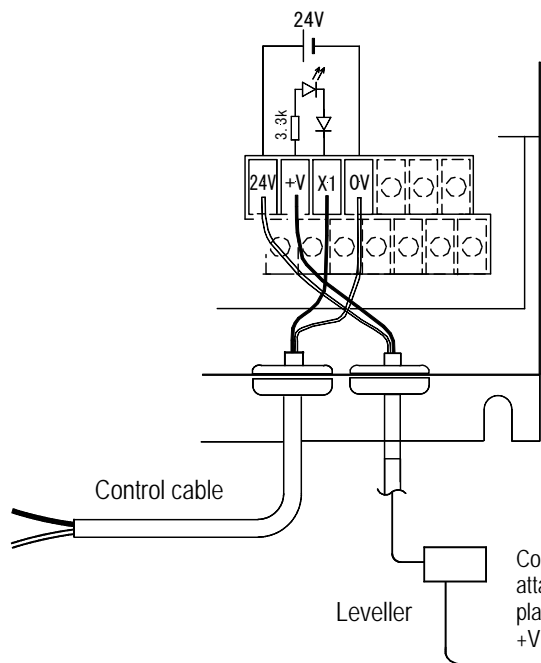

- ① Connect the separately placed hopper to the terminals of earth bar 1 and 2.
- ② Connect the level switch of the separately placed hopper to between the terminals 24V-+V.
- ③ Insert the pilot signal (Y1C, Y1A) of the controller for bowl feeder into between terminals X1-0V.
- ④ Use data of function J02 by setting it as 1 (between terminals X1-0V [ON when short-circuited]).

Connect the level switch attached to the separately placed hopper to between 24V - +V terminals.

In the above-mentioned connection, the separately placed hopper drives only when the bowl feeder is driving and also the level switch is ON (short-circuited between terminals 24V-+V). The current of DC24V/7mA flows in the level switch.

- *1 Please refer to the operation manual of the separately placed hopper.
- *2 Please refer to the previous page for the terminal X1-0V (external control).

(6) Connection of sensor/solenoid valve
Connecting method for basic use of sensor and solenoid valve is explained as below.

(Also refer to the block diagram of P.11.)

1. Overflow control by sensor

Connection of 3 wire type sensor

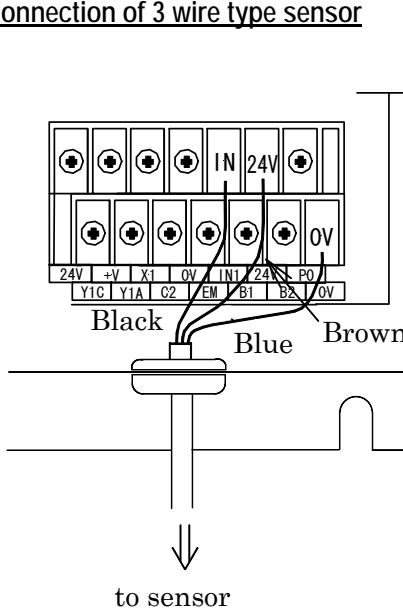

Connection of 2 wire type sensor

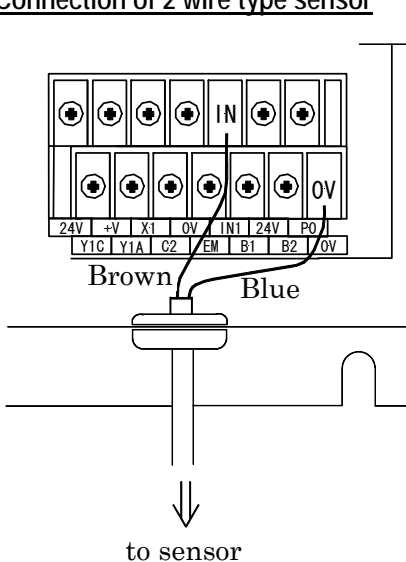

About breeder resistance

When the pilot light of the sensor blinks but such a symptom as that the controller cannot capture the signal of the sensor comes out, insert the breeder resistance. Normally the wiring is not required.

⚠ Caution

Driving stops when the power supply (DC24V) for the sensor is short-circuited (the display also is turned off). Please be careful of the wiring work sufficiently.

① The work confirmation sensor that detects the overflow on the chute is connected to terminals of 24V, 0V and IN1.

*1 The sensor that can be connected is limited to the one whose current consumption is 50mA or less and the NPN transistor output type that can be operated at the voltage of DC24V or the non-voltage contact output type.

*2 In case the direct current 2 wire type sensor is used, connect +side (brown) of sensor to IN1, and -side (blue) to 0V. (Depending on sensor used, color of lead wire may be different. In such a case, follow to the instruction of the sensor manufacturer.) Use the sensor of leakage current 1mA or less and residual voltage 3V or less. Turning off of the input signal may not be detected according to the kind of sensor. In this case, please connect the bleeder resistance to between terminals 24V-IN1 (tightened together with the sensor lead).

Bleeder resistance: 7~5.1kΩ, 1/2~1/4w

*3 Wiring of the non-voltage contact type is the same as that of the DC two wire type sensor. Bleeder resistance is not necessary.

② Please make the terminal IN1 open, and set the function H00 to 0 when you do not use the sensor. As the terminal IN1 is always monitored, if the setting is mistaken, there is a possibility that driving is not executed (The rightmost decimal point of the data display portion turns on a light when there is a signal of logic that instructs work existence in the sensor input) (Refer to the next page).

③ The signal logic of the sensor (normally open/normally close) can be changed by the function H00 (Refer to P.42).

⚠ Caution

Read the instruction manual of sensor used thoroughly. If anything is conflict with the above explanation, stop the wiring, and consult or check with the sensor manufacturer or contact NTN.

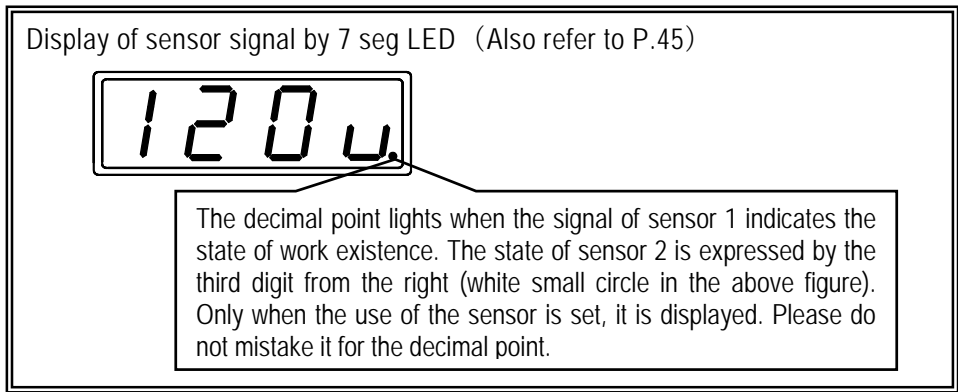

2. Air blow control during driving

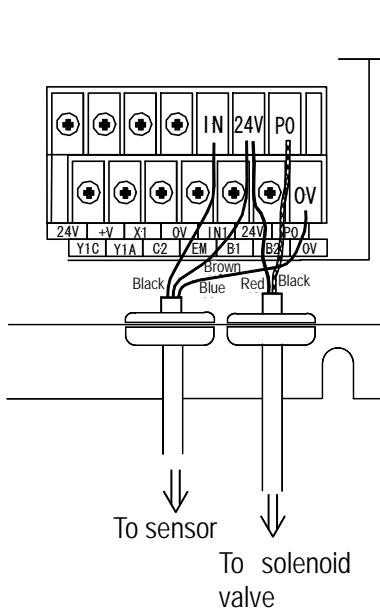

When connecting the solenoid valve for DC24V to between 24V-P0, the solenoid valve can be turned on during driving the load (being linked with driving). Please use it when you want to turn ON/OFF the air for tooling auxiliary in time along with parts feeder's driving.

The solenoid valve that can be connected is for DC24V. Use the one with the surge killer of 0.5W or less.

<Internal circuit of valve driving>

The transistor is turned on when conditions are satisfied, and the terminals P0 and 0V are in continuity.

Switching capacity: DC30V, up to 0.1A

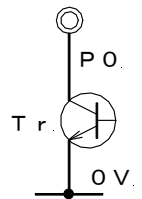

Note

The length of the cable connected to the output lines of 24V, P0 and 0V, etc. should be within 10m. Please wire the device to which a noise suppression element is attached.

Color of lead wire of the left figure is for reference. Please check the actual color of lead wire in the instruction manual of parts used, and connect.

(7) Multi-speed function

Speed data memorized in function is selected from outside.

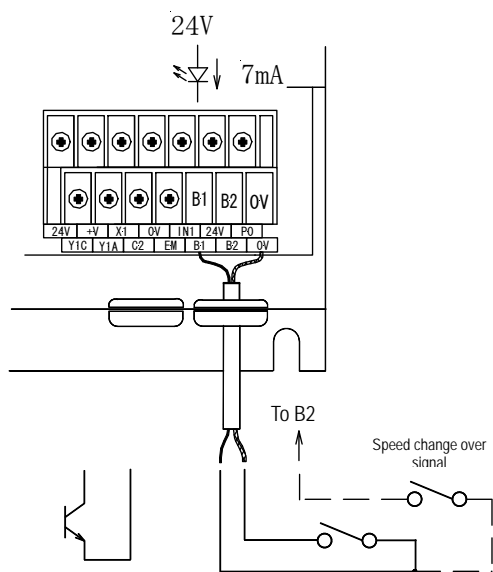

In case of transistor
(PLC / sensor etc.)

It is possible to drive at the speed (frequency and voltage value or % speed) memorized inside of the controller by using terminals B1 and B2.

Speed 1 is attained by short-circuiting the terminal B1 to 0V, speed 2 by short-circuiting the terminal B2 to 0V, speed 3 by short-circuiting both terminals B1 and B2 to 0V, and in case of both terminals being open, the speed is set by the panel (also refer to "Note on wiring" below).

Setting of each speed is possible by writing data directly in function H12-H17 (H18-H20 for constant amplitude mode) or sending the present value driven on panel to designated speed memory. (Refer to P.43, P.44 and P. 46)

Group selection of H12-H17 and H18-H20 is changed over automatically according to setting of driving mode of J05.

Speed No.		Speed 0	Speed1	Speed 2	Speed 3
Constant voltage mode	Voltage setting	Panel	H 1 2	H 1 4	H 1 6
	Frequency setting		H 1 3	H 1 5	H 1 7
Constant amplitude mode	% speed setting		H 1 8	H 1 9	H 2 0
Terminal B1		OFF	ON	OFF	ON
Terminal B2		OFF	OFF	ON	ON

* ON is short-circuited with 0V, OFF is opened.

*Please note that for constant amplitude mode, frequency is fixed to the set value of the panel only by designating the % speed data.

Note on wiring

The length of the cable connected to signal line such as B1, B2 and 0V shall be within 10m, and be careful of the noise sufficiently.

(8) Wiring of drive instruction output

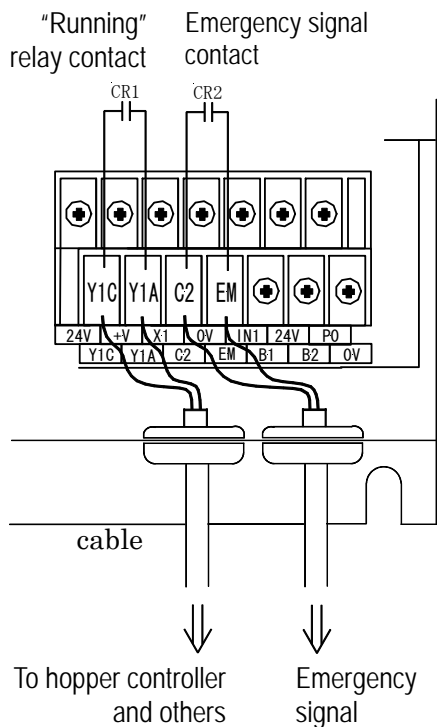

The contact signal that is linked with parts feeder's driving comes out between terminals of Y1C-Y1A. It is "Close" for driving and "Open" for the stop. This signal is used to output the driving signal to the separately placed hopper and other external instruments.

Note1 Specification of contact: Non-voltage contact a
Contact rating: AC250V, 0.1A (cos φ=1)

Note on wiring

When you connect the cable to Y1C, Y1A, C2 and EM, the length shall be within 10m, and if driving the solenoid valve and the relay, etc., please install a noise suppression element.

(9) Wiring of emergency signal (Multi output)

Refer to the above figure and P.10 for wiring.

Between C2-EM terminals

Signal selected from 5 signals of emergency signal, work shortage signal, overload warning signal, drive instruction output signal and drive preparation completion signal, is output.

Selection of signal is made by setting of function J12. Emergency signal is output when any of excess current trouble, overload trouble, CPU trouble and memory trouble comes out.

When emergency detecting circuit or CPU detects 4 troubles mentioned above, driving is stopped and emergency signal is output. Emergency signal is lighting until trouble is released. Content of the trouble is displayed on LED.

Moreover, by setting J12, this emergency signal is inverted to output or can be used as work shortage signal, alarm signal, in-driving signal (same motion as drive instruction signal Y1A-Y1C) or driving preparation completion signal

Content of alarm signal: When LIMIT lamp lights up or overload warning outputs, contact point is "Closed".

Driving preparation completion signal: When power supply of controller is ON and it is under condition of waiting signal input by external control without trouble, contact point is "Closed".

Note 1 Specification of contact point Zero voltage relay a contact point
Contact point rating: AC250V 0.1A(cosφ=1)

(10) Mounting of terminal cover

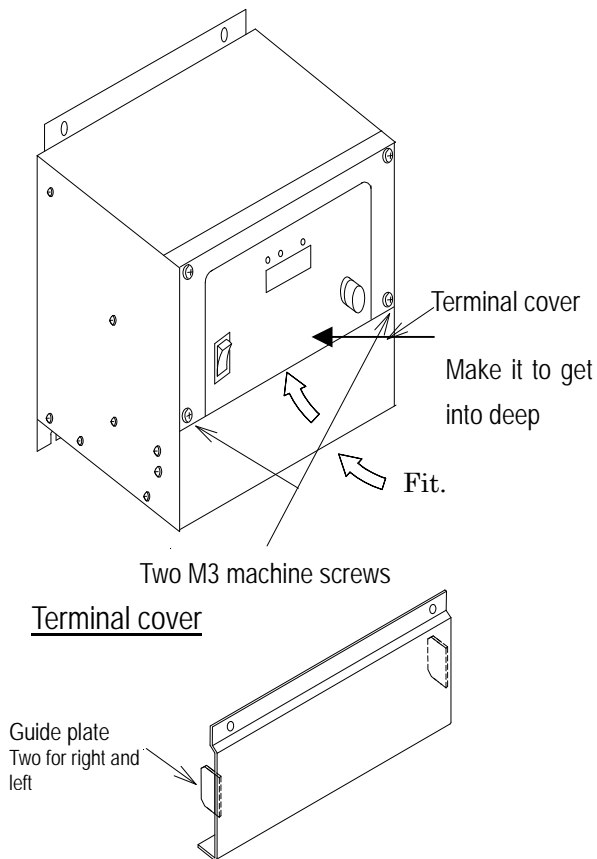

Please check whether there is a mistake in the connection of wiring.

Content to be checked

- A) Isn't there any mistake in the connection destination?
- B) Isn't there any mistake in the polarity?
- C) Isn't there possibility of short-circuit and earth fault?
- D) Is the earth surely connected? Was the protection continuity test executed?

- ① Guide is attached to the side of terminal cover. Try to slide the upper edge into the deep side of panel from bottom, trying to get the guide inside of the controller side face.
- ② Fix the cover with screw, supporting the cover not to fall down.

In case of the electric screw driver, use under the torque of $0.7\text{N}\cdot\text{m}$ or less. Over tightening may cause damage to screw. Moreover, take enough care for handling to avoid such as impact and dropping.

Then the wiring work is completed.

8. Driving and adjustment

Description of the operation panel

Caution

Only when 2 or 3 (both are on the operation panel) is selected by the function J02, the RUN/STOP key can be used.

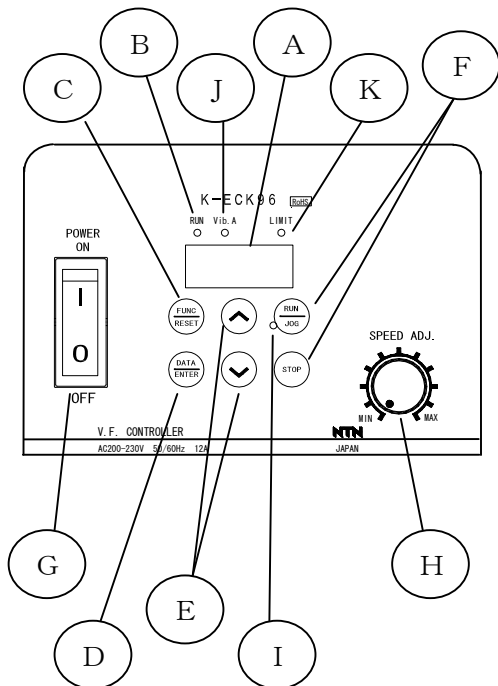

No	Name of each portion	Description
A	Data display portion (LED)	LED of 7 seg 4 digits. Monitoring of various kinds of data, display of setting, warning etc.
B	Pilot lamp	Pilot lamp lights when controller is in outputting (driving) state.
C	Function key (Reset key)	Switching to function setting mode and return, reset of emergency
D	Data key (Enter key)	Setting of data, switching of monitor content, setting of knob lock function
E	UP/DN key (Up/Down key)	Up/Down of function and data when data setting
F	RUN/STOP key	Drive/stop is operated when panel operation is selected.
G	Power supply switch	ON/OFF of main power supply of controller
H	Speed adjusting knob	Setting of the value of output voltage
I	JOG display lamp	It lights when JOG can drive.
J	Vib. A display lamp	It lights when constant amplitude function is ON
	LIMIT display lamp	It lights when reaching to limit of correction.

Outline of key operation

Key (Nominal name)	Short press (less than 2 seconds)	Long press (2 seconds or longer)
FUNC/RESET (Function)	Return from various modes to normal mode (normal screen). Reset of emergency signal at abnormal state.	Shift from normal mode (normal screen) to function mode
DATA/ENTER (Data)	Shift and return from normal mode (normal screen) or operation lock mode to data display mode. When data is changed, data is decided.	Shift from normal mode (normal screen) to knob lock mode and return
UP [Upward arrow] (UP)	Increment of each function and data (sending in order)	—
DOWN [downward arrow] (DN or Down)	Decrement of each function and data (sending backward)	—
RUN /JOG (Run)	Instruction of beginning of driving when selected on the operation panel. When the JOG function is selected, driving continues while it is pressing.	—
STOP (Stop)	Instruction of stopping of driving when selected on the operation panel.	—
STOP + UP (DN)	In case when the data of J00 and J10 are changed	—
UP + DN	It shifts to the data transfer mode.	—

(1) Specification check and preparation of driving

Please check again whether neither the form, the specification nor the power-supply voltage of the controller are wrong before turning on power.

- ① The form etc. is displayed on the controller operation side.
- ② Please make the speed adjustment switch "0" (Turn completely counterclockwise).

The adjustment of items of the above-mentioned ② and the following (4) and (5) is unnecessary for pre-adjusted cases such as purchase of finished products.

⚠ Caution
 Confirm certainly the setting of the function before driving. When the setting is mistaken, the magnet may burn.

Adjustment has done.

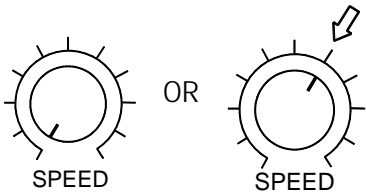

(2) Power supply ON

- ① Please make the power switch "ON", and confirm lighting or blinking of LED on the operation panel. When the power supply is ON, it turns to the normal display after soft version was displayed for about two seconds. Please note that no operation is accepted during the display of version information.

When external control input terminal is short-circuited (when the function J02 is under standard setting, it becomes operation command) , operation starts and RUN pilot lamp lights up, and LED changes from blinking to lighting condition.

When operation is at stop, LED becomes blinking and RUN pilot lamp turns off.

While power supply is ON, the cooling fan is always rotating.

⚠ Caution
 Turn neither power on/off switch nor the power supply on and off frequently. The controller may break down.

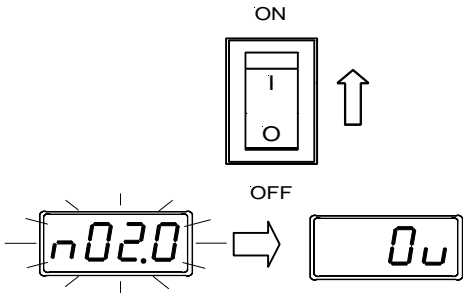

First figure b is model code and second to forth figures show version information.

When knob is fully turned to left.

(3) Check of function setting content

- ① It changes into the function setting mode if the function key is pressed for two seconds or more. As J or H is displayed, select the function group that you want to change with the UP/DN key and enter it with the data key. When function No is displayed, select function No to be confirmed with the UP/DN key. Here, present data is displayed when the data key is pressed, then confirm a set content. Please refer to P.34-44 for the confirmation of the concrete content and details of the setting method. Please return to the normal screen pressing the function key twice when the confirmation ends. The display automatically returns to the normal screen when the non-operating state continues for 20 seconds.
- ② There are some functions which prohibit the data change during driving. Moreover, please note that the controller might not operate when the setting is mistaken. (Refer to P.36-37.)



Function group display



Function No. display



Normal screen



(4) Driving/Adjustment

【Selection of feedback mode at time of driving】

① Kind of feedback modes at time of driving

Control operation at time of driving of ECK96 type controller can be selected. Control operations of feedback are following two kinds. However, in case constant amplitude mode is used, it is necessary to purchase vibration sensor (K-P1398) separately that is an option part, and install.

(A) Constant voltage mode: This is a mode generally used (Initial setting at the time of shipment). It controls the constant voltage so that the load (output) voltage becomes the value set by the speed adjustment knob.

(B) Constant amplitude mode: Select this mode when the weight variation of work is large or more stable feeding operation is required. Amplitude of parts feeder is made steady by feeding back the vibration sensor signal.

In case of driving under constant amplitude mode, calibration must be implemented in advance. After the calibration was completed, it moves automatically to constant amplitude mode.

② Selection method of feedback mode at time of driving

It is automatically selected if calibration is implemented. In case of changing manually, refer to the following. Before implementing calibration, please confirm that wiring of vibration sensor has been completed. Moreover, please note that in case the driving was started by selecting constant amplitude mode without implementing calibration, there is a possibility that normal amplitude may not be obtained.

【Manual switching method of feed back mode】

※Before switching feedback manually, please confirm that controller is in the stopping state (in case that the external control terminal is at stop side or panel control, press the STOP key). If it is difficult to cut off the external control, please select the panel control [2] with the driving method selection [J02] before the following procedure③. Then the controller stops.

① Display the function selection screen long pressing the function key. J or H is displayed.

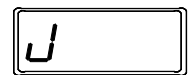

② Select the J function and press the data key. Any of J00 to J10 is displayed.



③ Select J05 with the UP/DN key and press the data key. Present set data (0 for constant voltage mode) is displayed.



④ Select data of mode you want to set with the UP/DN key and press the DATA key. (Refer to P.39 for the set value)



⑤ Display returns to J05 and corresponding display lamp lights up or turns off. In case of constant amplitude mode, Vib.A display lamp lights up.



⑥ Return to the normal screen pressing the function key twice.

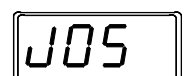

(A) Driving by constant voltage mode (Initial setting mode)

(A) – 1 Driving

Driving by constant voltage mode becomes to driving mode by adjusting output voltage and frequency manually.

- ① Please set the external control terminal to the driving side (short-circuit when the function J02 is 1). Moreover, please press the RUN key when you have set the driving control method to the panel control (2 or 3) with the function J02.

* Please refer to P.36 and P.39 for the selection of the driving method.

- ② The data display changes from blinking "0" to lighting, and the voltage value set with the speed adjustment knob is displayed and the voltage is output at the same time. Also the RUN pilot light lights.

Display during stop

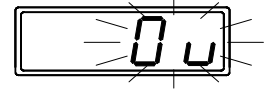

Display during driving

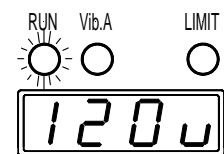

(A) - 2 Frequency adjustment

Please adjust the frequency while the parts feeder is driving. It becomes easier to know the degree of adjustment.

- ① Set the speed adjustment knob to scale 6-7 for the full wave system and scale 4-5 for the half wave system.
- ② Press the data key to display the frequency
- ③ Press the down key to adjust to the required amplitude while gradually lowering the frequency.

- * 1 Initial value of frequency at time of shipment from plant is 70.0Hz (Frequency notation)
- * 2 The display automatically returns to the normal screen when the non-operating state continues for 20 seconds.



Points for frequency adjustment

- Please adjust the frequency after works in the bowl are emptied.
- Please note that it becomes fast-forwarding if the key is kept pressed, and passes the resonance point (point of maximum amplitude) at a dash. It turns to a usual speed when sometimes releasing the hand from the key. When the resonance point has been passed, raise the frequency with the UP key over the resonance point once, and return to the operation of (A)-2 –③.
- The vibration becomes steady when driving at a little higher frequency (3-10Hz) than the resonance point. Normally it is used between 45~65Hz.
- Please note that the adjusting point for resonance frequency is different from one for ECB96 and is the same as for standard controller. When the load current exceeds 12A, make F/V curb of function J04 to P. (Refer to P.36 and 39)
- According to conditions such as the material of work, a necessary speed and the accuracy of array, the adjustment of the leaf spring might become necessary.
- Due to aging of leaf spring for parts feeder main body, the spring constant may drop and the amplitude may decrease. In such a case, the amplitude may recover by re-adjusting the frequency.

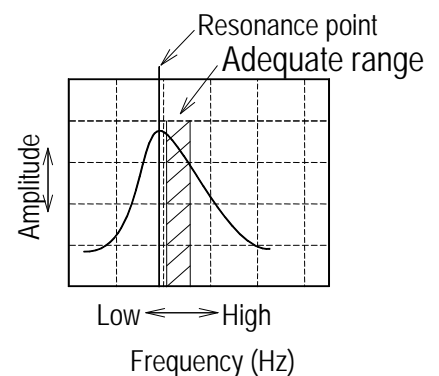

- ④ Please press the data key twice and return to the voltage display when the adjustment ends.

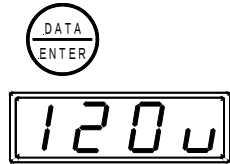

Fast-forward operation of frequency

When you want to change the frequency to a large degree, usage of the fast-forward operation makes the frequency change in a short time possible. But, please make the change while the parts feeder is vibrating, referring to (A)-2 of the previous page for the final minor frequency adjustment.

< Operating method >

- ① Stop the driving of the controller.
In case of external control (J02 is 0 or 1), please turn the driving signal OFF from outside. In case of panel control (J02 is 2 or 3), please press the "STOP" key.
While controller is driving, this operating method cannot be used.
- ② Display the frequency by pressing the "DATA" key.
- ③ When the "STOP" key is pressed, the digit (1st digit) at the left end blinks. This blinking part is a changed digit.
- ④ Every one press of the "STOP" key moves one digit each to right direction.
- ⑤ If the "STOP" key is pressed at the right end (4th digit), it turns to normal frequency display of all digits.
- ⑥ If the "UP" or the "DOWN" key is pressed at blinking position, frequency data of applicable digits can be changed.
- ⑦ If the "FUNC" key is pressed during change of frequency, it returns to display of the stopped condition. If the condition without any operation continues for 20 seconds, it automatically returns to display of the stopped condition. In such an event, if data was being changed, the changed data is reflected.
- ⑧ Usage of the frequency fast-forward operation is also possible for frequency H12, H14 and H16 of function by the same manner. But, it is limited only at the time when the controller is under stopped condition.

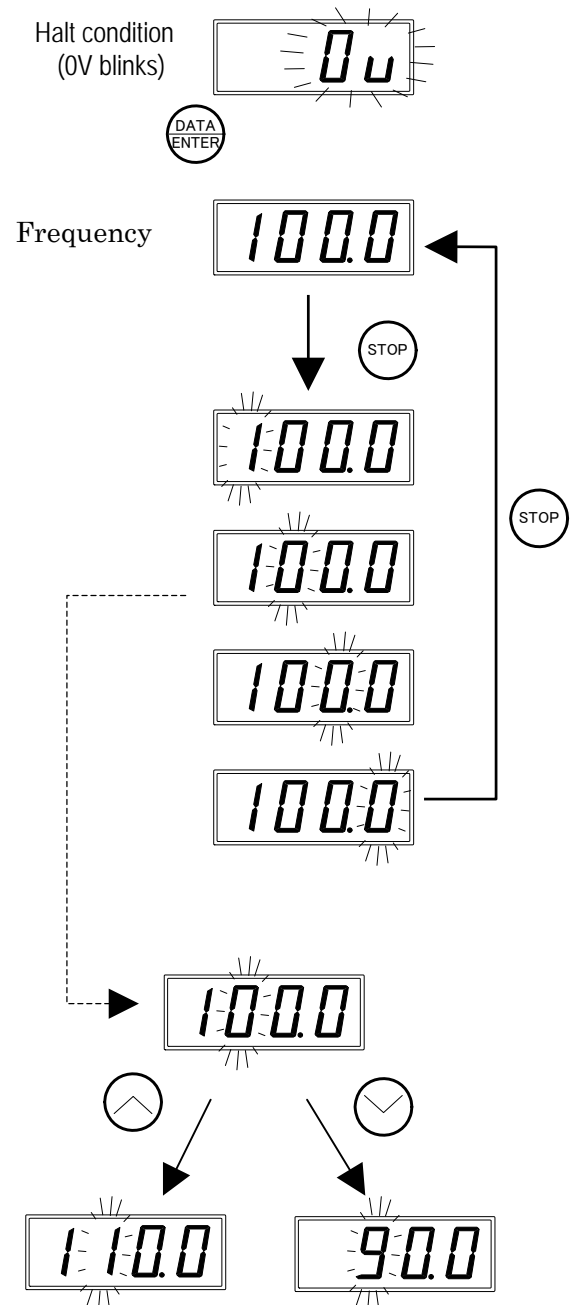

※ Up-and-down of digit can be done automatically. But, in case that it is outside the adjustment range, the up-and-down of digit is not possible.

(B) Driving by constant amplitude mode (Vib.A lamp lights)

(B) – 1 Driving

* Gain adjustment is necessary to drive by the constant amplitude mode. Gain can be automatically adjusted with calibration by the function J05. Manual gain adjustment is also possible (Refer to P. 30). Please refer to the following (B)-3 for the calibration method.

When the constant amplitude mode is selected, the display becomes the % speed display [○○P] as written right and the Vib. A lamp lights. When calibration is done, it is automatically changed to the constant amplitude mode. In case of manual, it is necessary to select by the function J05.

- ① Control method of driving is the same as for the constant voltage mode, and it is done by the external control terminal or the RUN/STOP button on the panel.
- ② During stop, LED is blinking, and when driving begins, the % speed set by the speed adjustment knob is displayed in the lighting state. Moreover, the RUN pilot lamp also lights.

(B) – 2 Frequency adjustment

- ① Please confirm that the F/V curb corresponding to load is selected (Function J04).
- ② Please adjust frequency as same as for the constant voltage mode (Refer to P. 26). The behavior becomes steady when driving at a little higher frequency (3-10Hz).

(B) – 3 Calibration (Gain adjustment)

Implementation method of calibration to drive by constant amplitude mode

- ① Please confirm that all wiring, installation of vibration sensor and frequency adjustment are completed and the controller is at halt condition (In case the external control terminal is at holt side or panel control, press the STOP key). When it is difficult to cut off the external control, please select the panel control [2] with the driving method selection J02 before the following procedure ④. Then the controller stops.
- ② Display the function selection screen long-pressing the function key. Either J or H is displayed.
- ③ Select the J function and press the data key. Any of J00~ J12 is displayed.
- ④ Select J05 pressing the UP or DN key, and press the data key. Present set data is displayed.
- ⑤ Select the data of 3 with the UP/DN key and press the data key (3: Calibration for the constant amplitude control).

Display at time when constant amplitude mode is selected

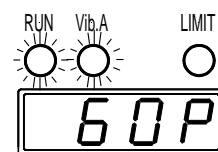

Display during stop

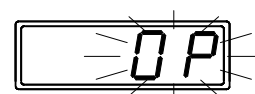

Display during driving

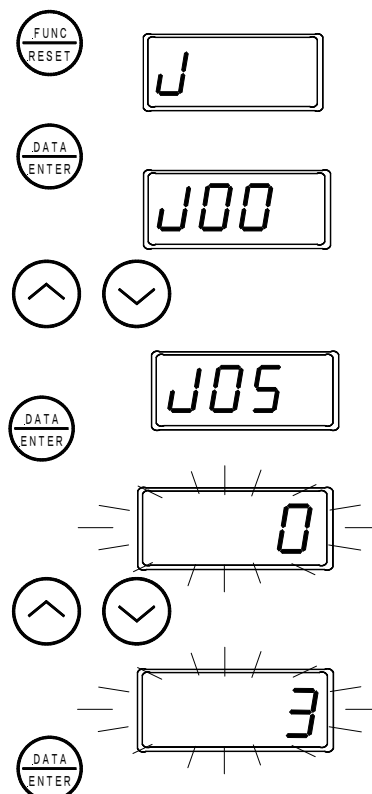
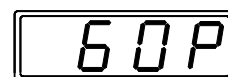

- ⑥ Calibration begins (LED displays gain value).
Normally gain value displayed becomes small gradually. Data key operation becomes invalid during calibration, and monitor of other data is not possible. When OL blinks during calibration, voltage is curbed but calibration is possible.
- ⑦ When calibration ends, load is stopped, setting the constant amplitude mode, it returns to the % speed set screen and pilot lamp (Vib.A) of the constant amplitude mode lights.
- ⑧ Please set the controller to the driving side (In case that the external control terminal is at driving side or panel control, press the RUN key).
In the description of ①, when setting of the J02 driving method was changed, please drive after returning to the normal state.
- ⑨ Please set the speed adjustment knob to the position where an appropriate vibration comes out.

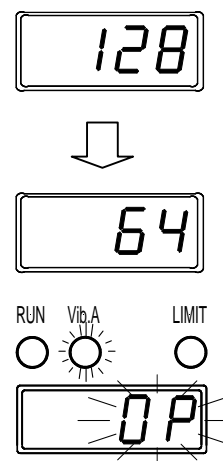

When the position of the speed adjustment knob is used at 8 or more, adjustment space of the controller becomes little and the LIMIT lamp becomes to light frequently. This displays that the LIMIT lamp has reached to the control limit, therefore it is recommended to use at scale of 4~6. When it can not be used at scale of 4~6, leaf spring adjustment of the part feeder is required.

In case of stopping calibration on the way

In case of stopping on the way, press the STOP key. Gain data at the time of stopping is memorized in H22 and calibration stops. The feedback (driving) mode becomes to the constant voltage mode.

In case of having failed calibration

When calibration did not end within two minutes or an appropriate value was not found, FE2 is displayed. Please confirm the installation of vibration sensor and the set value of F/V curb. When FE2 is displayed, it returns to the constant voltage mode and the value of gain data at the time when calibration ends is memorized. Display of error FE2 is reset pressing the function key.

Soft switch (INTEG)

It is a switch to switch the responsiveness of feedback and the variable range is 0 to 7. When the number is made smaller, responsiveness becomes faster but if it is too fast, vibration (wobble of vibration) occurs. It is set to 4 at the time of shipment. When wobble exists at the setting of 4, please make the number larger. Please use a small minus driver for adjustment. Soft switch is under the signal terminal board (Refer to P. 6).

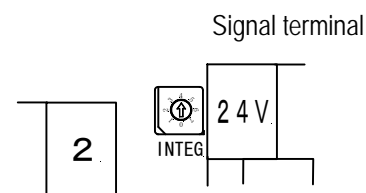

In order to make feedback steady, the rise and decay are slow comparing with the constant voltage mode. Please note that it can not correspond to the high speed response operation.

Manual adjustment of gain data

When setting has not been done well by automatic adjustment (movable iron core hits etc.) or an intentionally displaced adjustment is required, please adjust the gain (Data of H22) manually following the procedure below.

- ① Set the data of function J05 to 1 and drive load with the frequency set in (B)-2.
- ② Fully turn the speed adjustment knob clockwise.
At this time, magnet and movable iron core should not hit. If they hit, please change the frequency or down the MAX. % speed with H23 (Refer to P.44).
- ③ Select the function H22 to display data.
- ④ When data of H22 is adjusted first time, please make the number small gradually with the DN key. As output voltage rises gradually, please match to the data of the time when LIMIT lamp begins to light. Please change the data slowly. If fast-forwarding the data, feedback can not catch up and there is a possibility that the set value becomes too small.
When fine adjustment is made after automatic adjustment, please make the fine adjustment of the data with the UP/DN key as the data of H22 was set already. Please adjust the data so that the LIMIT ramp turns off positively (lights⇒blinks⇒turns off) at scale of about 8 when the speed adjustment knob is turned counterclockwise. There may be no region of blinking depending on type of equipment.
- ⑤ When adjustment to the position of lighting or turning off of the LIMIT lamp ended, please memorize the data pressing the data key.
- ⑥ Please press the function key twice and return to the normal screen (% speed setting screen).
- ⑦ Fully turn (sale 0) the speed adjustment knob counterclockwise once, and when turning clockwise, please confirm that the LIMIT lamp lights at scale of 9-10.
- ⑧ Please set the speed adjustment knob to the position where an appropriate vibration comes out.

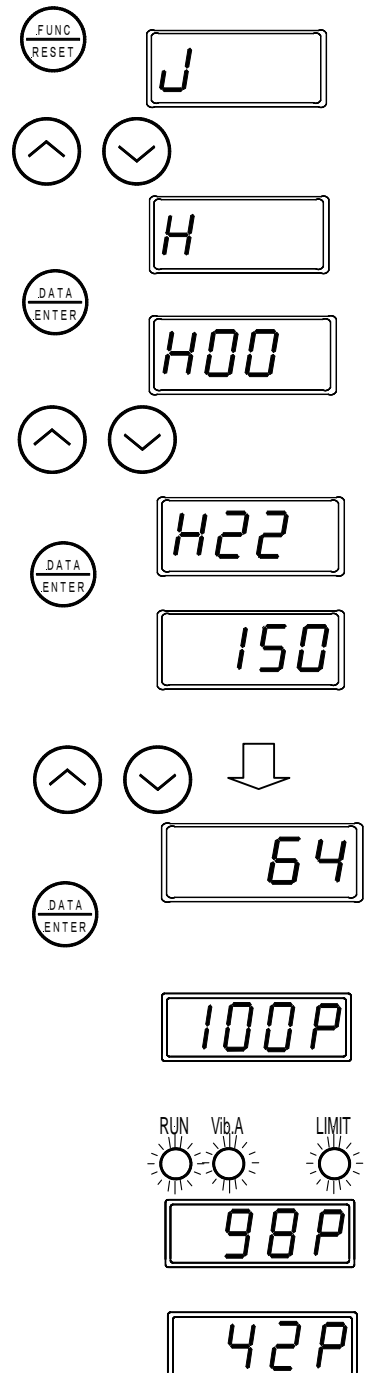

※When frequency was changed or leaf spring of the parts feeder was adjusted after the gain adjustment (calibration), please adjust the gain again (calibration).

(5) Speed (voltage, % speed) adjustment

① Please turn the speed adjustment knob gradually clockwise, and set it to the position where a necessary amplitude is obtained.

When an instruction of a proper position exists, please follow the instruction.

Usually it is used between scales 4-6.

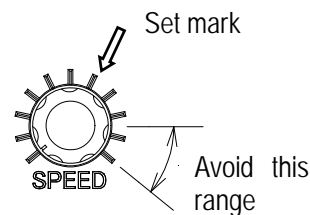

- *1 Please do not use the scale of 9 or larger. The voltage stability worsens when used.
- *2 Please note that the parts feeder doesn't operate when the sensor is confirming the work.

Note: When LIMIT lamp lights up at speed adjusting knob's scale of around 2-4, there is a possibility that calibration of gain did not complete accurately. In such a case, please make fine adjustment on gain value, referring to the clause of "Manual adjustment of gain data" in the previous page.

(6) Monitor

The display automatically returns to the normal screen when none of keys is operated for 20 seconds or more during each monitoring. The normal screen becomes to voltage display at time of constant voltage mode, % speed display at time of constant amplitude mode and speed No. display at time of using multi-speed function.



(6) - 1 Voltage monitor

In case of the constant voltage mode, set voltage is always displayed (Usual screen).

In case of the constant amplitude mode, % speed becomes usual screen. Therefore, please press the data key to monitor the present output voltage.

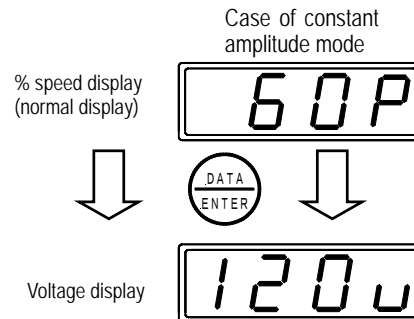

(6) - 2 Frequency monitor

① In case of the constant voltage mode, monitoring of the set frequency is possible by pressing the data key. In case of the constant amplitude mode, monitoring of the set frequency is possible by pressing data key when voltage is being monitored.

② In case of the constant voltage mode and the constant amplitude mode, change of the set frequency is possible by pressing the UP or DN key, when frequency is being displayed.

Note: While multi-speed function is used, it is not possible to change frequency data.

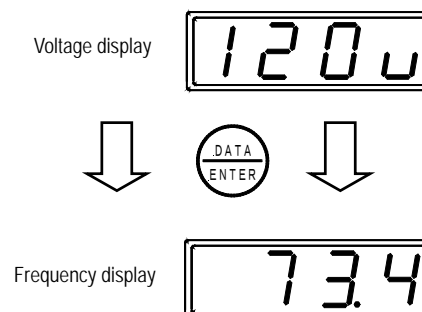

(6) – 3 Current monitor

- ① Present output current is displayed by pressing the data key during the frequency is being displayed. It can be a guide to know if there is any room in the operation state of load. Please note that error is large in the region of very small current (less than 2A).
- ② If the data key is pressed again during current is being displayed, it returns to the voltage display screen in case of operation by the constant voltage mode and to the % speed display screen in case of the constant amplitude mode. Moreover, at the time of using the multi-speed function, it returns to the speed No display screen.

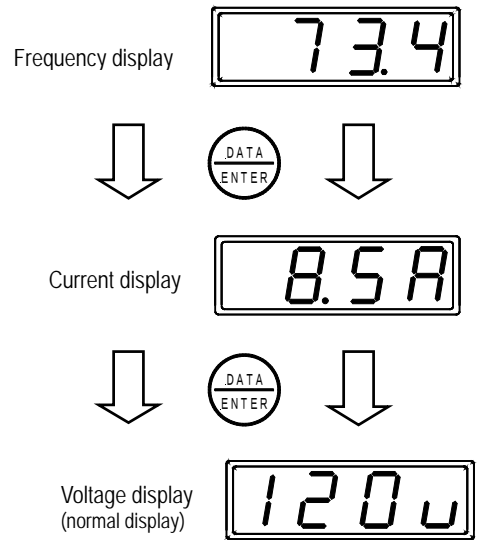

【List of monitor screens】

Drive mode	Normal screen	Data key One time press	Data key 2 time press	Data key 3 time press	Data key 4 time press	Data key 5 time press
Constant voltage mode	Voltage monitor 120V	Frequency monitor 62.4	Current monitor 8.6A	Voltage monitor (Normal screen)	Same as one time press	Same as 2 time press
Constant amplitude mode Resonance point tracking mode	% speed display 60P	Voltage monitor 120V	Frequency monitor 62.4	Current monitor 8.6A	% speed display (Normal screen)	Same as one time press
At time of using multi-speed function (Constant voltage mode)	Speed No display P1	Voltage monitor 120V	Frequency monitor 62.4	Current monitor 8.6A	Speed No display (Normal screen)	Same as one time press
At time of using multi-speed function (Constant amplitude mode, Resonance point tracking mode)	Speed No display P1	% speed display 60P	Voltage monitor 120V	Frequency monitor 62.4	Current monitor 8.6A	Speed No display (Normal screen)

(7) JOG driving

It is used for the time of forced driving such as maintenance, refill of work. Even if driving is being stopped by the external signal or overflow, forced driving is possible only during the run key is being pressed.

When this function is used, please select 1 (accept JOG drive) for the function J03.

During stopping by the external control (J02 is 0 or 1), JOG lamp lights and it displays that JOD driving is possible.

As JOG function is ON during lamp is lighting, output is ON only during RUN button is being pressed. When RUN button is disengaged, it stops.

In case that it is being driven by JOG, monitoring of data is not possible. When the other key such as the data key is pressed during JOG driving, the driving stops.

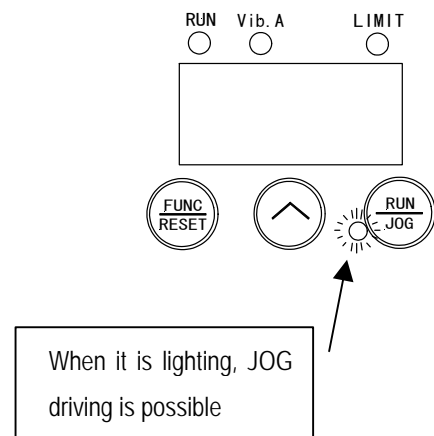

(8) Stop

- ① Please cut the driving signal from the outside (Make it to the stop side). Please press the STOP key when the selection of the driving method is "Panel control."

The data display becomes blinking of "0", and the RUN pilot lamp is turned off.

- * Please note that the driving does not stop immediately even if controller's power supply is turned off while driving.
- * We recommend that the driving method is an external control in a usual situation of use. Using the panel control is convenient when manufacturing or adjusting. Please refer to P.36 and 39 for the selection of the driving method.

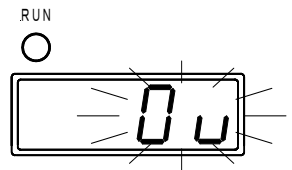

(9) Power supply OFF

- ① Please turn off the power after confirming that the driving has stopped.

When LED is turned off, "LV" is displayed once. This is not abnormal though. Moreover, it is likely to take more than five seconds for LED to go out.

- ② The electric charge remains in the internal circuit although LED goes out. Please do not open the terminal cover until the internal electric power condenser is discharged. (The estimate of the electrical discharge is about two minutes after LED of the operation panel went out.)

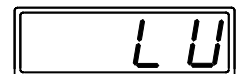
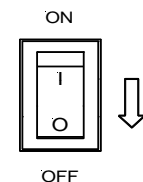

- *1 Never touch the charged part (terminal board and internal electric parts, etc.) for 2 minutes after the power supply OFF. There is a fear of an electric shock. The power supply terminal remains in charged state unless the main breaker is cut. Please cut the main breaker before opening the cover.
- *2 Please do the operation of neither switching of the displayed data nor setting of the function etc. after switching OFF of the power supply. When doing this, there is a possibility of displaying "Er2" when subsequently the power supply is turned on. Please reset it according to the resetting method in P.49 (3), when "Er2" is displayed by any chance.
- *3 Driving is continued until the internal charge is discharged even if this controller's power supply is intercepted by the emergency stop etc. Please put the driving stop instruction (driving signal OFF) separately by the external control signal to stop driving.

9. Setting of functions

(1) Setting of the function

① The function key is pressed for more than two seconds to change it to the function group selection mode.

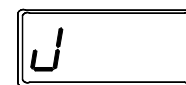

② When the function group (J or H) that you want to change is changed with UP/DOWN key and the data key is pressed, the function No is displayed.



③ The function No that you want to change is displayed with UP/DOWN key.



④ When the data key is pressed, the present data is displayed. The display is blinked when the data can be changed.

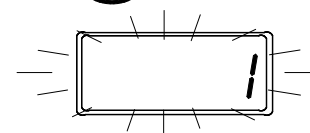

⑤ Data is changed with UP/DOWN key.

Note: The data of J00, J01, J04, J05, J06, J10, J11, J12 and H23 in the function can be changed only when the driving is stopping.

When you want to confirm data only, press the data key again or press the function key. It returns to the function display.

If the state of not pressing key continues for 20 seconds after data change, it returns to the normal screen without changing data. The changed data becomes valid at the time when the data key is pressed.

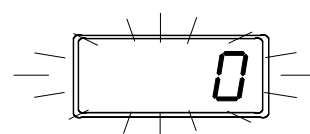

⑥ Press the data key, and write the data.

It returns to the function No. display.*1

※ When 1 is selected by the function J10, it returns the normal screen. (Refer to the boxed article below) *2

※ When 3 is selected by the function J05, it enters to the calibration work and after the calibration ends, it returns to the normal screen.

※ Please return to ③ when you want to change other functions in the same group.

Please press the function key when you change other function groups. The function group selection screen appears, then operate from ② again.



⑦ Please return to the normal screen by pressing the function key twice (once for the function group selection screen) when the change ended.



- *1 Please note that it returns to the normal screen without changing data when you press the function key without pressing the data key after the data has changed at ⑤.
- *2 Only when the function J10 is set to 1, it returns to the normal screen at the same time with resetting all data to the values at factory shipment. At this time, there is a possibility of beginning driving if there is a driving signal from the outside by any chance. Therefore turn OFF the control signal from the outside before resetting it. Moreover, when you rewrite the data of the functions J00 and J10, please press the stop key and UP or Down keys simultaneously. It cannot be changed with one key pressed.
Stop key and UP key: Data up (0 => 1)
Stop key and Down key: Data down (1 => 0)
- *3 In case that it is difficult to cut off the external control input when function data which cannot be changed during driving is changed, select the panel control (data 2 or 3) with driving method selection J02. (It stops with the selection).
- *4 Please note that the data of H23 can not changed unless J06 is 0.

(2) List of functions

There are two kinds of functions, J group that mainly sets functions and H group that mainly sets the data. Please refer to "Contents of functions" of P. 41~ for the detail of each function.

Initial values at the time of shipment are underlined.

<List of J group functions>

J №	Name & Set range (Initial value is underlined)	Change during driving	Record of set value
J00	Operation lock <u>0: Operation lock OFF</u> 1: Operation lock ON	Can not	
J01	Setting of current rating[A] Set range:0.5~14.0.*1 Use range: 2.0~12.0 <u>Initial value: 10.0[A]</u>	Can not	
J02	Selection of driving method 0: External control + Sensor <u>1:Reverse of external control + Sensor</u> 2: Panel control 3: Panel control + Sensor	Can	
J03	Selection of JOG driving method <u>0: Do not make JOG operation</u> 1: Accept JOG operation	Can	
J04	Setting of F-V curve F: Full wave type vibration main body <u>H:Half wave type vibration main body</u> P: Exclusive for G63 (ECB96 interchangeable) C:HF10 and others (High frequency system) 0~17 (Others)	Can not	
J05	Selection of constant amplitude control <u>0: Constant voltage control</u> 1: Constant amplitude control 2:Impossible of choice 3: Implementation of calibration	Can not	
J06	Setting of driving condition 0: Manual setting Set/change H23 data manually 1:Light weight high speed driving Set at 100% of max. speed <u>2:Light weight medium speed driving</u> <u>Set at 90% of max. speed</u> 3:Heavy weight medium speed driving Set at 80% of max. speed 4:Light weight low speed driving Set at 65% of max. speed 5:Heavy weight low speed driving Set at 50% of max. speed	Can not	

J No.	Name & Set range (Initial value is underlined)	Change during driving	Record of set value
J07	Not used	—	
J08	Not used	—	
J09	Display of error history Displaying latest error data (Content of protection function behaviors) up to three	—	
J10	Setting of initial value (All clear of memory) <u>0:Normal operation mode</u> 1:Rewriting the memory into the initial value	Can not	
J11*2	Change of carrier frequency* 0:20kHz <u>1:14kHz</u> 2:10kHz	Can not	
J12	Selection of functions of EM terminal <u>0:Contact point is "Close" at the time of problem</u> 1:Contact point is "Open" at the time of problem 2: Contact point is "Close" for work shortage 3: Contact point is "Close" when LIMIT lamp lights up or overload warning is ON 4:Contact point is "Close" during driving 5:Contact point is "Close" when driving preparation is completed	Can not	

* 1 Only when J11 is 2, useable up to 14.0A

* 2 Please note that frequency variable range or setting range of current rating changes by selection of J11.

<List of H group functions>

H№	Name & Set range (Initial value is underlined)	Change during driving	Record of set value
H00	Selection of functions of IN1 input <u>0:Driving with High input</u> 1:Driving with Low input (reverse) 2:Separate IN1 (reverse) from driving condition	Can	
H01	ON delay timer 1 <u>0.0</u> ~60.0 (Sec.)	Can	
H02	OFF delay timer 1 <u>0.0</u> ~30.0(Sec.)	Can	
H03	Impossible of choice	—	
H04	Impossible of choice	—	
H05	Impossible of choice	—	
H06	Soft start time 0.0~5.0(Sec.) <u>Initial value 0.5</u>	Can	
H07	Soft stop time 0.0~5.0(Sec.) <u>Initial value 0.3</u>	Can	
H08	Use of work shortage timer <u>0: Not used</u> 1:Detected by IN1 signal	Can	
H09	Work shortage detection time 1.0~120.0(Sec.) <u>Initial value 10.0</u>	Can	
H10	Work shortage reset time 0.1~30.0(Sec.) <u>Initial value 1.0</u>	Can	
H11	Impossible of choice	—	
H12	Frequency of speed 1 30.0~200.0(Hz) ^{*1} <u>Initial value 70.0</u>	Can	
H13	Voltage of speed 1 0~200(V) <u>Initial value 100</u>	Can	

H№	Name & Set range (Initial value is underlined)	Change during driving	Record of set value
H14	Frequency of speed 2 30.0~200.0(Hz) ^{*1} <u>Initial value 70.0</u>	Can	
H15	Voltage of speed 2 0~200(V) <u>Initial value 100</u>	Can	
H16	Frequency of speed 3 30.0~200.0(Hz) ^{*1} <u>Initial value 70.0</u>	Can	
H17	Voltage of speed 3 0~200(V) <u>Initial value 100</u>	Can	
H18	% speed of speed 1 0~100(%) <u>Initial value 50</u>	Can	
H19	% speed of speed 2 0~100(%) <u>Initial value 50</u>	Can	
H20	% speed of speed 3 0~100(%) <u>Initial value 50</u>	Can	
H21	Impossible of choice	—	
H22	Setting of gain 0~200 <u>Initial value 150</u>	Can	
H23	Setting of MAX. % speed 30~100(%) <u>Initial value 90</u>	Can not	
H24	Impossible of choice	—	
H25	Scaling 40~ <u>100</u> <u>Initial value 70</u>	Can	

*1 Only when 0 is selected with J11, variability up to 250.0Hz is possible..

*2 Only when J06 is 0, change is possible.

(3) Contents of the function (details)

J Group (Relating to function setting)

Display	Name	Content
J00	Operation lock Initial value: 0 Unchangeable during driving	<p>To prevent the operational error, operations by other than a specified key can be made unacceptable. <u>The data of J00 can be changed only by pressing the stop key and UP or Down key at the same time for the operational error prevention.</u></p> <p>0 : Do not lock 1 : Lock</p> <p>When locked, the data change of other than a specific function (J00 and J10) is prohibited (The RUN/STOP key is effective when the panel operation is specified). The access to the function data is possible though the data cannot be changed. When the data change operation is done during the operation lock, the characters of Loc are displayed with blinking. Moreover, when the lock is released when the knob lock (Refer to P.45) is set, the knob lock is also released because the operation lock is given priority. Please set it again when the knob lock is necessary.</p>
J01	Setting of current rating Initial value: 10.0A Unchangeable during driving	<p>The current rating of the connected main body of the vibration is set. So as not to exceed this current value, the controller automatically adjusts the output voltage of the load. The initial value is set to 10.0A. If this value is not set, the overload protection function doesn't operate normally. Therefore set it for the parts feeder whose current rating is 2.0A or more before driving. Possible set range is 0.5~12.0A (0.5~14.0A in case J11 is set 2), but the use range is 2.0~12.0A (2.0~14.0A in case J11 is set 2). <u>In case it is set less than 2.0A, load current cannot be measured accurately and there is a possibility that overload warning function does not work properly.</u></p> <p><u>Note: Please limit the setting exceeding 12.0A only for short time driving for such as adjustment.</u> Driving exceeding 12.0A for more than 30 minutes makes controller life shorter extremely.</p> <p>In case setting of J11 is 0, it is recommended to use (20kHz) under less than 10.0A.</p>
<p>Note on limit of current rating</p> <p>The maximum value to be able to set the output voltage is limited first by the F/V curve (Refer to P.47), and even within the set range of the F/V curve, when it exceeds the set current, the controller automatically lowers the output voltage to make load current within the set value (Driving continues). At this time, the output voltage and the OL are alternately displayed (OL blinks). This condition means that the vibration is insufficient even main body of the vibration is in the state of full load. Please check whether no abnormality exists. While OL is blinking, warning signal comes out between C2-EM terminals (in case setting of J12 is 2). It is selected as whether output is made at stage of warning or after became to abnormal condition.</p> <p>Moreover, when the output voltage becomes 20V or less but load current does not drop less than the set value, driving is stopped by an overload abnormality (OL lights). In this case, emergency signal is output at C2-EM terminals (in case emergency output is selected at J12). (Refer to P.41)</p>		

Display	Name	Content
J02	Selection of driving method Initial value: 1	<p>The input condition of the driving ON/OFF signal is switched. External control terminal: X1 terminal Overflow detection sensor input: IN1 terminal</p> <p>0: Driving by AND with the external control terminal signal and the overflow detection sensor (Both conditions must be on the driving sides).(X1 open: Driving)</p> <p>1: Driving by AND with the reversed logic of the external control terminal signal and the overflow detection sensor (Both conditions must be on the driving sides).(X1 open: Stopping)</p> <p>2: Driving/stopping by RUN/STOP keys of the operation panel</p> <p>3: Driving by AND with the operation panel RUN/STOP keys and the overflow detection sensor.</p> <p>Even during panel locking, the RUN/STOP key is effective when the panel control has been selected. It is not possible to get the ON/OFF delay timer to work with the external control terminal signal.</p>
J03	Selection of JOG driving Initial value: 0	<p>Even when the driving is stopping by the external control (J02 is 0 or 1), <u>it is possible to drive compulsorily only while the RUN button of the operation panel is being pressed</u>. Please use it at the initial supply of the work or discharging or at the time of adjustment. The JOG lamp (green) on the side of the RUN button lights when JOG drive can be done.</p> <p>0 : JOG driving function is not used 1 : JOG (compulsory single) driving function is used.</p> <p>Even if a knob lock or the operation lock is set, the JOG driving is effective.</p>
J04	Setting of F-V curve Initial value:H Unchangeable during driving	<p>The F/V curve is set according to the main body used. <u>Data can be changed only while driving is stopping</u>. Please surely <u>confirm the setting before driving</u>. When the setting is mistaken, the accident such as burning of the magnet will occur.</p> <p>As the data setting changes with the main body used, <u>set it to an appropriate value with surely reading P.47</u>, when you change the data of the F/V curve.</p> <p>F: Selection of curves of full wave system such as N25 H: Selection of curves of half wave system such as N40(Initial value) P: Exclusive for G63 and interchangeable curve with ECB96 C: Selection of curves of high frequency system such as HF10 0~17: Specifying directly of curve No</p> <p>* When you use No 0-17, please examine the characteristic of the load current and set it after investigations not so as to get overloaded. * When a special specification such as S20, N25-1 is driven by half wave, please select also the full wave for the F/V curb.</p>
J05	Selection of feed-back mode Initial value: 0 Unchangeable during driving.	<p>Feedback data at the time of driving is selected.</p> <p>0: Output voltage becomes to a stable <u>constant voltage mode</u>.</p> <p>1: Amplitude of vibration main body becomes to a stable <u>constant amplitude mode</u>.</p> <p>2: Impossible of choice 3: Gain data used by the constant amplitude control is automatically set. After setting data, it automatically becomes to the constant amplitude mode.</p> <p>* Unusable for even applicable main bodies using inapplicable bowls or modified main bodies. Moreover, it may be unusable also if number of leaf springs was changed.</p>

Display	Name	Content
J06	Setting of driving condition Initial value: 2 Unchangeable during driving.	Outline of calibration for constant amplitude mode and of driving conditions at constant amplitude mode is set. 0: Manual setting Data of H23 is made to be changeable. Please set when this data is changed. 1: Light weight high speed driving Max. speed 100%. It is set when high speed driving is envisaged. 2: Light weight medium speed driving Max. speed 90%. Set at time when you want to drive the same degree as conventional one. 3: Heavy weight medium speed driving Max. speed 80%. Set at time when driving for a little heavy works is envisaged. 4: Light weight low speed driving Max. speed 65%. Set at time when you want to drive light weight work in slow speed. 5: Heavy weight slow speed driving Max. speed of 50%. It is set in case slow speed driving for heavy work is expected.
J07	Impossible of choice	This function cannot be used.
J08	Impossible of choice	This function cannot be used.
J09	Display of error history Initial value: Non	Because the latest error data (protection function operation content) are memorized up to three, the memorized content can be displayed with UP key and DOWN key. The content of an error that actually occurs at maintenance etc. can be confirmed afterwards. Because data is automatically overwritten, data cannot be changed or cleared by operation.
J10	Return to initial value (All clear) Initial value: 0 Unchangeable during driving	When data is set to 1, it rewrites all data and frequency of the function into the initial values at shipping from NTN. It is used when resetting from the beginning or clearing data content for return from error. All the values are substituted into the initial values, therefore record the present values first. The data change can be effected only by pressing STOP key and Up key or DOWN key simultaneously because of the operational error prevention. It automatically returns to a normal mode after rewriting the data. Therefore leave the external control signal in the state of "Stop."

Display	Name	Content
J11	Change of carrier frequency Initial value: 1 Unchangeable during driving	<p>This changes carrier frequency to control the output. When it was driven at initial value of 1 (carrier frequency 14kHz) and indication from the measuring device outputs error due to noise etc., please try to change setting. Output method of high-frequency noise changes and the influence may be decreased. If it was judged to be usable, please drive changing the carrier frequency.</p> <p>0: 20kHz (Max. output frequency increase from 200.0 to 250.0Hz) 1: 14kHz (Max. control current is 12.0A) 2: 10kHz (Max. control current becomes 14.0A)</p> <p>[Note]</p> <p>① In case the carrier frequency is set 0, variable range of driving frequency increases to 30.0~250.0Hz. Please use the output current under 10.0A or less.</p> <p>② In case the carrier frequency is set 2, modulation frequency becomes audible range and noise (high frequency sound) generates from the part feeder. When there are workers around, there may be a case that it is unusable.</p>
J12	Selection of terminal EM function Initial value: 0 Unchangeable during driving	<p>Signal output to terminal EM is selected.</p> <p>0: In case protection function works, contact point "Close" signal outputs between terminals EM-C2. Emergency signal output (Close for emergency)</p> <p>1: In case protection function works, contact point "Open" signal outputs between terminals EM-C2 Emergency signal output (Close for normal)</p> <p>2: Contact point is "Close" when work shortage warning is ON.</p> <p>3: Contact point is "Close" when LIMIT lamp lights up or overload warning is ON.</p> <p>4: In-operation signal interlocking to driving of parts feeder outputs on EM-C2 terminal. (Becomes the same behavior as terminal board Y1A-Y1C)</p> <p>5: When driving preparation is completed, contact point "Close" signal is output between EM-C2 terminals.</p> <p>Driving preparation completion: Condition that protective function is not working and external control (0 or 1) is selected at function J02. (It is standby condition of driving instruction or in-driving condition) In case driving stopped due to emergency or panel operation was selected, contact point becomes "Open".</p>

H group (Related to data setting)

Display	Name	Content
H00	Input logic of IN1 Initial value: 0 (Refer to P.45 for display of input state of IN1)	Signal logic of sensor input 1(IN1) is reversed. Time until actual operation changes depending on setting times of ON delay timer 1 and the OFF delay timer 1. 0: When the terminal IN1 is connected to 0V (Low level), the OFF delay timer 1 works to stop the driving. The ON delay timer 1 works at the High level to start the driving. 1: When the terminal IN1 is connected to 0V, the ON delay timer 1 works to start the driving. The OFF delay timer 1 works at the High level to stop the driving.
H01	ON delay timer 1 Initial value: 0.0 (second) Set range: 0.0~60.0seconds	The time between when sensor 1 (IN1) stops to confirm the work and when parts feeder starts driving is set. Note) It is effective only when the data selection (J02) of the driving method is 0, 1 or 3 (the use of the overflow detection sensor is selected).
H02	OFF delay timer 1 Initial value: 0.0 (second) Set range: 0.0~30.0seconds	The time between when sensor 1 (IN1) starts to confirm the work and when parts feeder stops driving is set. Note) It is effective only when the data selection (J02) of the driving method is 0, 1 or 3 (the use of the overflow detection sensor is selected).
H03	Impossible of choice	This function cannot be used.
H04	Impossible of choice	This function cannot be used.
H05	Impossible of choice	This function cannot be used.
H06	Soft start time Initial value: 0.5 (second) Set range: 0.0~5.0 seconds	Set the soft start time. The output voltage is gradually raised from 0V until it reaches the set value. The time of the raising is set. The minimum set time is 0.0 second, but actually it is about 50msec.
H07	Soft stop time Initial value: 0.3 (second) Set range: 0.0~5.0seconds	Set the soft stop time. The output voltage is gradually lowered from the set value until it reaches 0V. The time of the lowering is set. The minimum set time is 0.0 second, but actually it is about 50msec.
H08	Use of work shortage timer Initial value: 0	It selects as whether work shortage timer is used at IN1. 0: Does not use 1: Uses the signal IN1 (Work shortage is detected with overflow sensor.) In case it is set 1, IN1 signal is sent to work shortage timer (H09) and work shortage reset timer (H10).

Display	Name	Content
H09	Work shortage timer Initial value: 10.0 (second) Set range: 1.0~120.0seconds	Set the time of the timer that detects the work shortage. When the signal continues for a set duration, the work shortage signal is set. The logic with which the timer works depends on H00, and the timer works when the input selected with H08 during driving (output ON) is Low (the reverse-operation is also possible by H00). In case time is up, noP is displayed as work shortage signal on LED, and signal is output between C2-EM terminals (in case selected with J12).
H10	Work shortage reset timer Initial value: 1.0 (second) Set range: 0.1~30.0seconds	Set the time of the timer that resets the work shortage signal. When the signal continues for a set duration, the work shortage signal (timer) is reset. The logic with which the timer works depends on H00, and is the same operation as the OFF delay timer (the work shortage signal is reset). noP display goes off with reset, and signal output between C"-EM terminals also goes OFF.
H11	Impossible of choice	This function cannot be used.
H12	Frequency data of speed 1 Initial value: 70.0(Hz)	In case of multi-speed driving, it is an area memorizing frequency data of speed 1. Setting range: 30.0-200.0Hz 【30.0~250.0Hz】 *1
H13	Voltage data of speed 1 Initial value: 100(V)	In case of multi-speed driving, it is an area memorizing voltage data of speed 1. Setting range: 0-200V
H14	Frequency data of speed 2 Initial value: 70.0(Hz)	In case of multi-speed driving, it is an area memorizing frequency data of speed 2. Setting range: 30.0-200.0Hz 【30.0~250.0Hz】 *1
H15	Voltage data of speed 2 Initial value: 100(V)	In case of multi-speed driving, it is an area memorizing voltage data of speed 2. Setting range: 0-200V
H16	Frequency data of speed 3 Initial value: 70.0(Hz)	In case of multi-speed driving, it is an area memorizing frequency data of speed 3. Setting range: 30.0-200.0Hz 【30.0~250.0Hz】 *1
H17	Voltage data of speed 3 Initial value: 100(V)	In case of multi-speed driving, it is an area memorizing voltage data of speed 3. Setting range: 0-200V

* 1 Value in 【 】 is for the case J11 carrier frequency is set "0:20kHz".

Display	Name	Content
H18	% speed data of speed 1 Initial value: 50(%) <u>for constant amplitude mode</u>	It is an area where the % speed data of the speed 1 is memorized when the multi-speed function is used at the time of the constant amplitude control being selected. Setting range: 0~100% (Value to the output of vibration at time of calibration. It is also possible to transfer the size of frequency set with the knob during the driving directly to the memory.)
H19	% speed data of speed 2 Initial value: 50(%) <u>for constant amplitude mode</u>	It is an area where the % speed data of the speed 2 is memorized when the multi-speed function is used at the time of the constant amplitude control being selected. Setting range: 0~100% (Value to the output of vibration at time of calibration. It is also possible to transfer the size of frequency set with the knob during the driving directly to the memory.)
H20	% speed data of speed 3 Initial value: 50(%) <u>for constant amplitude mode</u>	It is an area where the % speed data of the speed 3 is memorized when the multi-speed function is used at the time of the constant amplitude control being selected. Setting range: 0~100% (Value to the output of vibration at time of calibration. It is also possible to transfer the size of frequency set with the knob during the driving directly to the memory.)
H21	Impossible of choice	This function cannot be used.
H22	Setting of gain Initial value: 150 <u>for constant amplitude mode</u> Set range: 0~200	It sets the gain adjustment data of the vibration sensor. When calibration was done, the value is automatically written. But manual writing is also possible. In case of driving by constant amplitude mode, gain adjustment (calibration) is necessary in advance without fail.
H23	Max % speed Initial value: 90 Unchangeable during driving <u>for constant amplitude mode</u> Set range: 30~100	It sets the max. output voltage <u>at the time of implementing the calibration.</u> When it is changed, please set J06 to 0. It sets by % corresponding to the 200 V power supply voltage. Please set in case that movable core comes into contact unless max. voltage is curved. In case movable core came into contact during calibration, please decrease the % value with J06 or this value and then try to calibrate again.
H24	Impossible of choice	This function cannot be used.
H25	Scaling Initial value: 100% <u>for constant amplitude mode</u> Set range: 40~100%	Down this value when the max. speed obtained by the calibration is too fast (such as that the driving speed becomes 20~30%). Down the speed of the time when the knob is fully turned clockwise, with % rate of max. speed obtained by calibration. The knob setting is reallocated, making the downed max. speed as 100%. Therefore the range used is nearby the center and the setting becomes easier.

Panel lock

In order not to have the set value changed even if an operator touches the knob by mistake, it is recommended to turn on the panel lock during the automatic operation. There are two kinds of panel locks, an **operation lock** set by the function and a simple **knob lock**.

- The operation lock can turn the function on and off by the function J00, and prohibits all the operations and changes in data, excluding minimum necessary functions.
- The knob lock is a function that locks the data simply, and locks only the data of the voltage value, the % speed and the frequency. Other operations and changes in data are possible. This lock is not a mechanical lock but it is the one to prohibit the operation of changing data electrically.

Operation of knob lock

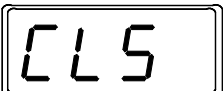
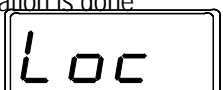
Operation and display	Description
Setting 	A long pressing on the data key for three seconds or more on the normal screen turns ON the knob lock. The characters of Loc blink for two seconds. Such as the change in the data of the function is not locked. The operation lock is given priority when the operation lock is set.
Release 	A long pressing on the data key for three seconds or more during the knob lock turns the knob lock OFF (release). The characters of CLS blink for two seconds. When the operation lock is released, the knob lock is also released.
In case when a prohibited operation is done 	When the prohibited operation is done while locking, the characters of Loc blink for two seconds, showing that the operation is prohibited. It returns to the normal screen after blinking. The display blinks similarly when operated while locking.

Notes related to LED display (Also refer to P.19)

The decimal point on the extreme right of 7seg LED displays the input state of sensor 1 (IN1). Because the dot lights when the input of the sensor is in the condition side of the drive stopping (stop of work supply), the signal state of the sensor can be confirmed.

- *When the driving is stopping with the sensor signal, "RUN" ramp blinks.

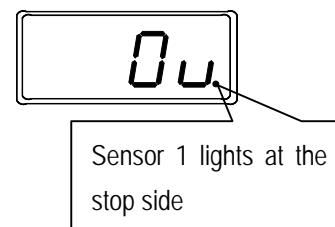

Display at multi-speed driving

When the multi-speed driving is selected, the selected speed mark P1 etc. is displayed preferentially. When you want to confirm the set voltage and the frequency of driving, please press the data key. The display changes in order of speed No display ⇒ voltage display ⇒ frequency display ⇒ current display ⇒ speed No display at every time the key is pressed. If the key is not pressed for more than 20 seconds, it returns to the speed No display.



When the constant amplitude mode is selected, the order becomes speed No display ⇒ % speed display ⇒ voltage display ⇒ frequency display ⇒ current display ⇒ speed No display.

Data setting of multi-speed driving

The data for the multi-speed driving has two methods, the method to write data directly in the function and the method to transfer the present driving data. The method to write directly is a method to examine both the frequency and the voltage data or the speed % data due to driving in advance and write the value as the data of the corresponding function No. (Refer to the page of Function).

The method to transfer the driving data is a method to transfer/overwrite the data that is driving the machine now to the directly corresponding function. Setting is done as follows. Please transfer the data while driving without fail. When the data is transferred while stopping, vibration will stop because the output voltage of 0V is transferred. When you want to transfer the data at the time of the constant amplitude mode, please drive by constant amplitude mode. The corresponding function (H12-H17 or H18-H20) is selected automatically according to the present driving mode.

- ① The parts feeder is driven by the driving data to be memorized.
(To memorize the data of the slow driving, drive at an actually slow speed.)

In case of constant voltage mode



- ② The UP key and the DN key are pressed at the same time while driving.
Speed number P1 is displayed in LED.



- ③ The speed number which you want to be memorized is selected with the UP/DN key.
P1-P3 is selected.

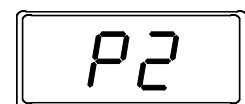

- ④ Press the data key
Present driving data is written in the designated speed function. Function H12~17 or H18~H20 to be written in is automatically selected according to driving mode. Moreover, in case of constant voltage mode, both frequency and voltage data are written in at once. After written in, the display returns to the original state.

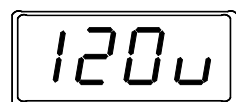

F/V curve

To protect the magnet for driving the part feeder, the frequency-voltage recession curve is installed. Please switch to the F/V curve to be used according to the main body and the drive system used. The F/V curve can be switched by the function J04. The line of the set F/V curve is the upper boundary value for a set voltage in each frequency. It is independent of the overload protection function by the current rating, and the output voltage is limited when it reaches the upper boundary value of the F/V curve even if it is not an overloading state.

Selection of F/V curve

Function J04	Full wave driving main body	Half wave driving main body	High frequency main body
F (F-V curve №3)	S05~S20, L20, MD10~MD20 K10~K20 ^{*2} , N25~N40 ^{*2}	[S20] ^{*1} [N25·1] ^{*1} Refer to P.36 and 39 also.	—
H (F-V curve №9)	—	K20, N32~N40, G50·1 G63, SV01~SV06, SV1~SV3, S30, V01~V12, MD30	—
P (F-V curve №6)	—	G63	—
C (F-V curve №15)	—	—	—
0~17	[Special use]		

F-V curve

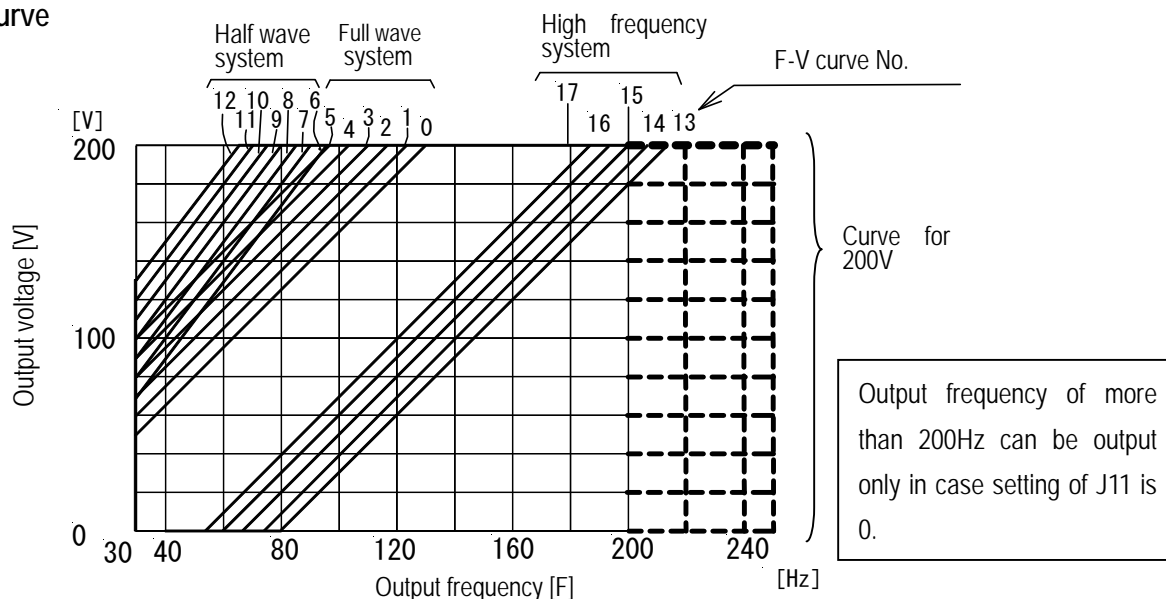



- *1 This F-V curve is exclusively for FCK96 (interchangeable with ECB96). Please note that the limit value is different from those of other small size frequency variable controller series.
- *2 Number of F/V curves installed in this controller is 18 in total, but usually select the one from the three of F/H/P/C. When you use № 0-17, examine the characteristic of the load current and set it after investigation if it leads to overloading.
- *3 Please do the overload protection of the magnet by the setting function of the current rating. However, when it is not possible to protect it by the setting function of the current rating of such as minute current load, the protection by the F/V curve is the alternate.
- *4 When the parts feeder made by other company is used or a curve other than for F/H/P/C is selected, there is the case that protection by the F / V curve is impossible. Please note that NTN is not responsible for the trouble that originates from these circumstances.

10. Protection/Warning function



(1) Protection function

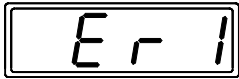
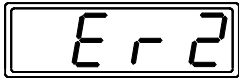

The protection function is an important function to protect a controller or peripheral equipments. When the protection function operates, it is short-circuited between terminals C2-EM (There may be a case that no signal comes out depending on setting of function J12). The reset work is necessary when stopping due to the protection function. Please reset it after investigating the cause that made the protection function to operate and executing the countermeasure (Refer to the next page for reset).

Protection function	Content	Display
Overcurrent/earth protection OC lighting (Hardware detection and software detection)	<ul style="list-style-type: none"> When the output current of 1.5 times more than the controller current rating flows, it stops controller's driving and protects the internal circuit and wiring (Refer to P. 51). When detected by hardware, the subsequent operation accepts only power off. 	
Overload abnormality OL lighting	<ul style="list-style-type: none"> When the output current exceeding the current rating set by the function flows and it cannot be improved by decreasing the output voltage, it stops the controller's driving to protect the load. 	
CPU abnormality Er1 lighting	<ul style="list-style-type: none"> When operation time abnormality of CPU is detected, it stops the controller's driving. When it can not be reset by power supply OFF, it is very likely to be breakdown. 	
Memory abnormality Er2 lighting	<ul style="list-style-type: none"> The controller's driving is stopped by detecting the memory abnormality (abnormal value is found in the set data). (Refer to ⑤ of the next page) 	

(2) Warning function

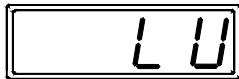
Warning function is a function to inform various kinds of information such as driving condition. In case "Work shortage", "Overload warning" and "LIMIT LED light-up" operate, signal following to setting of function J12 is output between C2-EM terminals. In case warning operation is released, warning display and signal are reset automatically.

Warning function	Content	Display
Overload warning OL blinking	In case the output current exceeding current rating value set with function J01 flows and enters into limiting action to decrease the output voltage, it draws attention by blinking OL. If the limiting action is released, it is automatically reset.	
Work shortage noP blinking	In case the work shortage timer is setup, noP is displayed. It is reset by setup of the reset timer.	
Voltage shortage or excess voltage LV lighting	In case undervoltage or overvoltage of direct current intermediate circuit (power supply voltage) is detected, driving of controller is stopped and LV is displayed. In case voltage returned to normal value, it is automatically reset. Even it operates, warning signal is not output.	

Warning function	Content	Display
Fan alarm F-Er lighting	It is displayed when fan stopped. Driving is stopped without rotational signal from fan motor and the fan alarm is displayed. When the fan starts to rotate, the alarm is reset and the driving of load starts again.	
Gain is unclear. FE2 lighting	It is displayed when the gain value was not found for within two minutes while doing the auto calibration or the calibration or when an appropriate gain value was not found within the searching range. It is reset with the function key. (Refer to P.29)	

(3) Resetting

Please reset it according to the following instructions when the protection function operates and the driving is stopped. The warning function for such as work shortage is an automatic reset.

- ① Please certainly make the external control signal "Stop." When it is on driving side, there is a possibility of becoming abnormal again according to circumstances because it begins to move simultaneously with the return.
- ② Please make the knob of speed adjustment to "0: turn completely counterclockwise."
- ③ It is possible to reset it by pressing the function key or turning off the power supply switch once (LED turning off + five seconds). However, abnormality of the hardware detection (over current etc.) can be reset only by "turning off power supply switch." Please turn off the power when it is not possible to reset it even if the function key is pressed.
- ④ Please investigate the cause according to the content of the operating protection function, and take actions such as checking of the wiring and the load, or replacement if necessary. Please work after turning off the main power supply without fail when there is a possibility to touch the energized part when wiring etc. is confirmed.
- ⑤ Please clear all data by the function J10 after resetting when an memory abnormality (Er2) comes out. However, all data returns to the default value when the data is all cleared, therefore set data again without fail before driving. Please refer to P.24 and after for resetting work. For data before all clear operation, refer to submission document to users or contact the supplier.

Even under the condition that memory abnormality comes out, it is possible to enter the function mode by long pressing the function key.

In case all cleared, there is a possibility that parts feeder starts to drive at the same time with recovery. Therefore, be sure to operate all clear under "Condition that condition of driving stop is ON".

*Please contact NTN when it is not possible to reset it.

 **Danger**
Please do inspection after turning off the power supply without fail.

 **Caution**
Please do not reset it while the driving signal is on. There is a possibility to begin moving suddenly.

 **Caution**
The drive stopping with the RUN/STOP key is effective only when the panel control is selected by the driving method selection.

11. Trouble shooting

Please investigate the following points if a trouble occurs by any chance. In addition, check the output voltage (Refer to P.52) for the case of paragraphs of (2) and (3). When the cause is not clear and it needs to consult NTN on the troubling state, please inform of the content in detail and concretely with referring the followings in order to be able to take measures as soon as possible.

Contents of troubles	Estimated causes	Reference pages/documents/measures
(1) It doesn't vibrate.	• Wrong connection of power supply or specification	Check it referring to the paragraph of the specification in P.53.
	• Wrong Wiring	Refer to I/O connection method in P.10.
	• Broken fuse	Checks it referring to the paragraph of the specification in P.53.
	• Short-circuit between X1-0V and 24V-+V or they are not opened.	Check the connection of wiring, referring to the paragraph of the wiring for the external control input in P.16 and after.
	• The sensor is confirming the work.	Remove works in the chute.
(2) The vibration doesn't increase.	• Wrong connection of power supply or specification	Check it referring to the paragraph of the specification in P.53.
	• Wrong adjustment of frequency	Refer to the paragraph of the method of driving and adjustment in P.23.
	• Broken leaf spring	Refer to the manual for the main body.
	• It is fixed with metal fittings for transportation.	Refer to the manual for the main body.
	• Loose leaf spring	Refer to the manual for the main body.
	• Overweight of bowl/chute	Refer to the parts feeder guide book.
(3) The vibration fluctuates.	• The power-supply voltage exceeds the permissible value of the controller and fluctuates.	Check voltages of the power supply and the output, and remove the cause of the voltage fluctuation.
	• It is in the resonance state.	Refer to the paragraph of the method of driving and adjustment in P.23. Refer to the manual for the main body.
	• The amount of works in the bowl changes greatly.	The amount of works charged is made uniform.
	• Bad adjustment of the soft switch	Refer to the soft switch adjustment in P. 29.
(4) The control from the outside is not effective.	• Wrong wiring	Check the connection of wiring, referring to the paragraph of the wiring for the external control input in P.16 and after.
	• The polarity of wiring is different.	Check the connection of wiring, referring to the paragraph of the wiring for the external control input in P.16 and after.
	• The sensor is confirming the work.	Remove works in the chute.
	• Wrong setting of function	Refer to the paragraph of the setting method of the function in P.34 and after.
(5) The control of the Overflow sensor is not effective.	• Wrong setting of function	Refer to the paragraph of the setting method of the function in P.34 and after Check the driving method, logic switching of sensor etc.
	• Mistaking because of long time of ON/OFF delay timer	Check the timer setting value, and check it in a short time.

Contents of troubles	Estimated causes	Reference pages/documents/measures
(6) The voltage and the frequency cannot be set.	<ul style="list-style-type: none"> Isn't the operation lock or the knob lock turning on. 	<p>Refer to the function in P.34 and after or the paragraph of panel lock in P.45.</p> <p>Release the operation lock or the knob lock.</p>
(7) Reset is not effective.	<ul style="list-style-type: none"> There is a signal of the driving instruction. 	<p>Press the reset key after the controller is stopped (Refer to P.49)</p>
(8) The output voltage doesn't go up.	<ul style="list-style-type: none"> The limiter by the F-V curve operates. 	<p>The setting of the F-V curve is confirmed (Refer to P.47).</p>
(9) The beat sound is generated.	<ul style="list-style-type: none"> Plural parts feeders are driven with driving frequencies that are approximate with each other. 	<p>Separate the driving frequencies by 5Hz or more, or drive by the same frequency.</p> <p>Adjustment of a leaf spring may be needed for some case.</p>
(10) OL blinks immediately.	<ul style="list-style-type: none"> The setting of the current rating is wrong. 	<p>Refer to the paragraph of the setting method of the function in P.34 and after. Set the correct current rating.</p>
(11) Driving cannot be controlled by the sensor signal.	<ul style="list-style-type: none"> 2 is set for driving method (J02). 	<p>Referring to clause of setting of functions of P.34 and after, set the driving method (J02) of function to 0 or 1 or 3.</p>
(12) Calibration is slow. It stops immediately.	<ul style="list-style-type: none"> Bad installation of the vibration sensor. 	<p>Refer to P.14-15. Please confirm the installation of the vibration sensor.</p>
(13) Gain can not be found during calibration.	<ul style="list-style-type: none"> Noise is appearing on the vibration sensor. 	<p>Try to change the general purpose cable to the shield cable. Try to change the wiring method of the lead wire.</p>
	<ul style="list-style-type: none"> Work is in. 	<p>Remove work.</p>
(14) Even if the speed adjustment knob was turned, amplitude does not quite become larger.	<ul style="list-style-type: none"> Noise is appearing on the vibration sensor. 	<p>Try to change the general purpose cable to the shield cable. Try to change the wiring method of the lead wire.</p>
	<ul style="list-style-type: none"> Defect of vibration sensor installation or wiring. 	<p>Check vibration sensor installation and wiring.</p>
	<ul style="list-style-type: none"> Bad adjustment of the soft switch 	<p>Please try to make the set value of the soft switch small.</p>
(15) LIMIT lamp lights up even if the speed adjustment knob is turned up only a little.	<ul style="list-style-type: none"> Noise is appearing on the vibration sensor. 	<p>Try to change the general purpose cable to the shield cable. Try to change the wiring method of the lead wire</p>
	<ul style="list-style-type: none"> Defect of vibration sensor calibration adjustment. 	<p>Try to adjust manually the gain data with the function H22 (P.30)</p>
	<ul style="list-style-type: none"> Defect of vibration sensor installation or wiring. 	<p>Check vibration sensor installation and wiring.</p>

Contents of troubles	Estimated causes	Reference pages/documents/measures
(16) Even if the speed adjustment knob was fully turned, amplitude is insufficient..	• Gain adjustment was not done well.	Perform calibration again or adjust the gain by hand. Refer to P.28~P.30.
	• Frequency is not properly adjusted.	Adjust frequency. Refer to P.26.
	• Leaf spring is fatigued or broken.	Please check the leaf spring of the vibration main body, then adjust the frequency.
(17) OC lights.	• Short-circuit of the load side.	Please check vibration main body and wiring etc. If there is no abnormality at the load side, there is a possibility of the controller's breakage.
	• Setting error of controller.	Check if there is any mistake in setting of frequency and current rating etc.

*Measuring method of output voltage

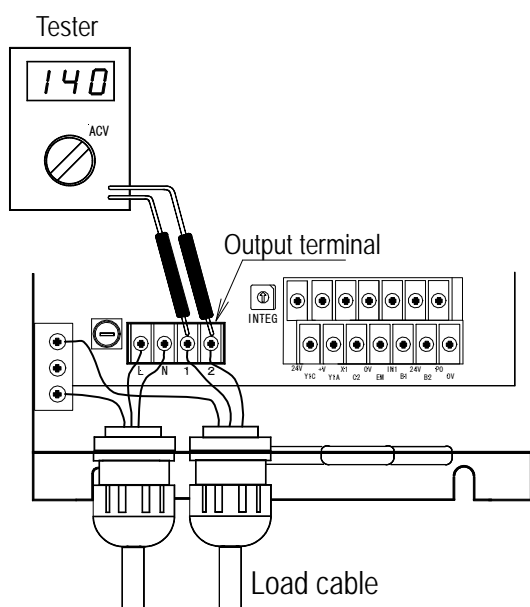

Warning

Be careful that a human body and an unnecessary object must not touch the charged part. It causes an electric shock and a fire.

- 1) As for the measurement of the PWM wave shape, the instruction value is different according to the measuring instrument used. Please regard the indicated value on the controller's operation panel to be main, and treat the instrument reading as a reference value.
- 2) Measurement range is "AC" in principle. However, for the actual measurement, please check "For the case of measuring the sign wave PWM wave pattern of inverter output" in the instruction manual of the measuring device or document of the manufacturer.
- 3) Please open the terminal cover after turning off the power supply without fail.

12. Specification

Part number		K-ECK96
Input	Power supply	AC200V~230V±10% 50/60Hz (Automatic switching)
		Inrush current 50A or less (For initial 1 cycle) *1
Output	Control method	Sine wave PWM control
	Capacity of control rating	12.0A (For continuous driving. Rating for short time driving of 30 min or less is 14.0A)
	Frequency setting	30.0~200.0Hz (In case that carrier frequency is 10KHz or 14 KHz) 30.0~250.0Hz (In case that carrier frequency is 20KHz)
	Voltage setting range	0~200V *2
Service power supply		DC24V 100mA (max)
Adaptive function*5	Constant voltage function	Fluctuation of output voltage ±3% or less for the fluctuation of power supply voltage of ±10%*3
	Constant amplitude function	Signal of vibration sensor is fed back and amplitude is made to be stabilized. Amplitude variation of ±10 % at the time when feedback is OFF, is controlled within ±3%*4
	External control input	Drive and stop are possible by external signal (NPN/PNP open collector connection is possible)
	Overflow control	Driving/Stopping by sensor signal is possible. (With timer function: ON 0.0~60.0 sec, OFF 0.0~30.0 sec)
	Drive instruction output	Non-voltage contact (linked to parts feeder) open/close capacity: AC250V 0.1A or less
	Overload protection	Derating function of output voltage by setting current rating of load
	Others	Various protection functions such as soft start, soft stop, short-circuit are installed.
Fuse		10A [Fuji Terminal Industry Co., Ltd. FGBO φ5.2×20 or the equivalent]
Noise immunity		1000Vp (Pulse width 1μsec, by noise simulator)
Ambient temperature, humidity		0 to +40°C, 35~85%RH (No condensation allowed)
Protection structure		IP 20
Ambient atmosphere (Contamination level)		Contamination level II, Height: 1000m or less However, there must not be corrosive gas. The substances giving trouble to electronic parts, resins, and sheet metals such as awful dust, water, oil and solvents must not splash.
Mass		About 3.5kg
Applicable vibration main body		Only for G63

※Leak current and earth leakage breaker

When you install an earth leakage breaker, please select the one of 200mA or more for the sensible current. It is because there is a leakage current of a high harmonic wave to the earth in the controller of the inverter method. Although the leakage current of the controller during driving is about 1mA, the vibration main body changes depending on the driving condition. Therefore it should be about 10mA/unit as a standard.

- * 1 Please note controller's inrush current when you install a protection equipment such as an earth breakage breaker. Please select the one of an appropriate current rating from the characteristic graph of the breaker so that the breaker does not work with the inrush current. Moreover, when plural controllers are connected, the inrush current also becomes larger. When number of controllers increase, please devise measures such as using plural breakers or turning on the power source staggering the time.
- * 2 It is for the power supply voltage of 200V or more. When the power supply voltage falls, the maximum output voltage is limited by the power supply voltage.
- * 3 The output voltage stability level is a value when the setting of the output voltage is 60-170V.
- * 4 As the constant amplitude performance changes according to the setting conditions of the vibration main body, it is not a guaranteed value. Moreover, please note that it is not possible to follow the swift speed change (incl. drive stopping) as the responsive performance becomes slow.
- * 5 Various adaptive functions are installed besides the items shown. Please refer to P.5 for details.

[Outside dimension diagram]

K-ECK96

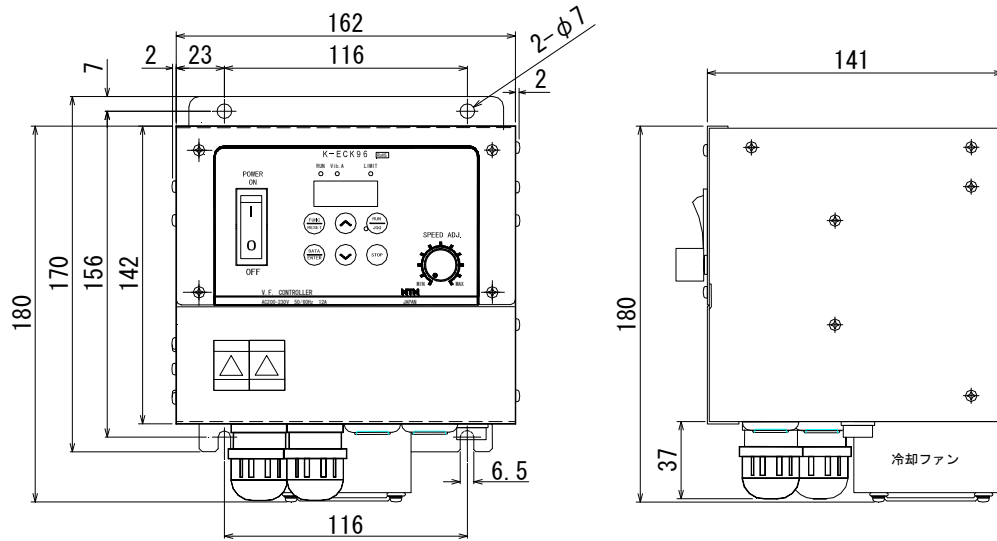

Vibration sensor(オプション : K-P1398)

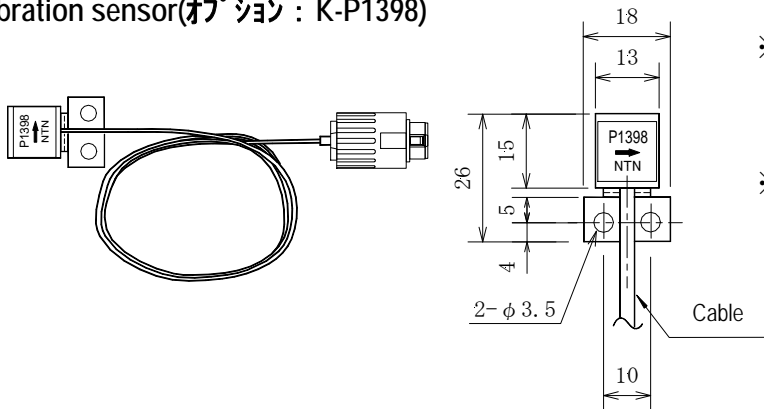

※This figure is just for reference. Details of part layout may be different from those of the actual product.

Please refer to P.7 also for installation.

※Vibration sensor is an option part. Purchase it separately.

Refer to P.14~P.15 for installation of vibration sensor. Moreover, refer to directions of vibration sensor for the specification of vibration sensor.

*Replacement method of fuses

Refer to P.53 for the applicable fuses.

1. The main power supply (main breaker) to which the controller is connected is turned off, and energizing to the controller is stopped.
2. The cause due to which the fuse is cut is investigated, and proper measures are given.
3. Remove fixing screws on terminal cover and then remove the cover. (Refer to P.11)
4. The cap comes out a little forward when twisting the cap of the fuse holder (Refer to P.6) upper the electric power terminal board counterclockwise by 90° while lightly pushing it to the interior, and pull out the cap as it is.
5. The fuse (cartridge) comes out with the cap too, then remove the fuse from the cap.
6. Please push a new fuse of the same rating as the broken fuse (confirm the current rating/voltage etc.) into the cap. Please dispose of the broken fuse in an appropriate manner.
7. Insert the cap and the cartridge into the fuse holder, and twist the cap clockwise by 90 degrees with pushing it to the interior to lock. Since the position (direction of the rotation) in which the cap enters is decided, do not push it forcibly.)
8. Put back the terminal cover as original state and fix it with screws.
9. After safety is confirmed, the main power supply (main breaker) is turned on.

⚠ Warning

The power supply must always be turned off and the engineer must work when replacing fuses.

- This manual might be changed without notice for the function improvement etc.

Revised : Nov. 1, 2012 3th edition

Issued : Dec. 1, 2011

NTN

NTN Corporation
PRECISION EQUIPMENT DIVISION

1578 Higashi-Kaizuka, Iwata, Shizuoka 438-8510 Japan
PHONE : 81-0538-37-8104 FAX : 81-0538-37-8128

All rights reserved. ©NTN Corporation 2012